



# **Agilent E6630A Wireless Connectivity Test Set**

**Getting Started Guide**

# Notices

© Agilent Technologies, Inc. 2013

No part of this manual may be reproduced in any form or by any means (including electronic storage and retrieval or translation into a foreign language) without prior agreement and written consent from Agilent Technologies, Inc. as governed by United States and international copyright laws.

## Trademark Acknowledgements

Bluetooth<sup>®</sup> is a trademark owned by Bluetooth SIG, Inc., U.S.A, and licensed to Agilent Technologies.

cdma2000<sup>®</sup> is a US registered certification mark of the Telecommunications Industry Association.

WiMAX<sup>®</sup> is a US trademark of the WiMAX Forum.

Copyright 2013 Agilent Technologies Inc.

Licensed under the Apache License, Version 2.0 (the "License"); you may not use this file except in compliance with the License.

You may obtain a copy of the License at: <http://www.apache.org/licenses/LICENSE-2.0>

Unless required by applicable law or agreed to in writing, software distributed under the License is distributed on an "AS IS" BASIS WITHOUT WARRANTIES OR CONDITIONS OF ANY KIND, either express or implied.

See the License for the specific language governing permissions and limitations under the License.

## Manual Part Number

E6630-90001

## Print Date

December 2013

Printed in USA

Agilent Technologies, Inc.  
1400 Fountaingrove Parkway  
Santa Rosa, CA 95403

## Warranty

**The material contained in this document is provided "as is," and is subject to being changed, without notice, in future editions. Further, to the maximum extent permitted by applicable law, Agilent disclaims all warranties, either express or implied, with regard to this manual and any information contained herein, including but not limited to the implied warranties of merchantability and fitness for a particular purpose. Agilent shall not be liable for errors or for incidental or consequential damages in connection with the furnishing, use, or performance of this document or of any information contained herein. Should Agilent and the user have a separate written agreement with warranty terms covering the material in this document that conflict with these terms, the warranty terms in the separate agreement shall control.**

## Technology Licenses

The hardware and/or software described in this document are furnished under a license and may be used or copied only in accordance with the terms of such license.

## Restricted Rights Legend

If software is for use in the performance of a U.S. Government prime contract or subcontract, Software is delivered and licensed as "Commercial computer software" as defined in DFAR 252.227-7014

(June 1995), or as a "commercial item" as defined in FAR 2.101(a) or as "Restricted computer software" as defined in FAR 52.227-19 (June 1987) or any equivalent agency regulation or contract clause. Use, duplication or disclosure of Software is subject to Agilent Technologies' standard commercial license terms, and non-DOD Departments and Agencies of the U.S. Government will receive no greater than Restricted Rights as defined in FAR 52.227-19(c)(1-2) (June 1987). U.S. Government users will receive no greater than Limited Rights as defined in FAR 52.227-14 (June 1987) or DFAR 252.227-7015 (b)(2) (November 1995), as applicable in any technical data.

## Safety Notices

### CAUTION

A CAUTION notice denotes a hazard. It calls attention to an operating procedure, practice, or the like that, if not correctly performed or adhered to, could result in damage to the product or loss of important data. Do not proceed beyond a CAUTION notice until the indicated conditions are fully understood and met.

### WARNING

A WARNING notice denotes a hazard. It calls attention to an operating procedure, practice, or the like that, if not correctly performed or adhered to, could result in personal injury or death. Do not proceed beyond a WARNING notice until the indicated conditions are fully understood and met.

## In This Guide...

This guide contains the following information:

### 1 Quick-Start

This chapter explains how to initialize the test set and generate and view a signal.

### 2 Front and Rear Panel Features

Refer to this chapter for information on front- and rear-panel key functionality, and display annotations.

### 3 Test Set Operating System

This chapter describes the Microsoft Windows configuration and the settings used with the Agilent test set software.

### 4 Using Microsoft Windows

The information in this chapter provides some guidelines for using the Microsoft Windows feature capabilities with the test set.

### 5 Troubleshooting

This chapter details some basic steps that may solve any problems you are experiencing with either the test set or Microsoft Windows.

## Warranty

This Agilent Technologies product is warranted against defects in material and workmanship for a period of one year from the date of shipment. During the warranty period, Agilent Technologies will, at its option, either repair or replace products that prove to be defective.

For warranty service or repair, this product must be returned to a service facility designated by Agilent Technologies. Buyer shall prepay shipping charges to Agilent Technologies shall pay shipping charges to return the product to Buyer. However, Buyer shall pay all shipping charges, duties, and taxes for products returned to Agilent Technologies from another country.

## Where to Find the Latest Information

Documentation is updated periodically. For the latest information about this test set, including firmware upgrades, application information, and product information, see the following URLs:

<http://www.agilent.com/find/e6630a>

To receive the latest updates by email, subscribe to Agilent Email Updates:

<http://www.agilent.com/find/emailupdates>

Information on preventing test set damage can be found at:

<http://www.agilent.com/find/tips>



# Contents

## 1 Quick-Start

About the Test Set	10
Instrument Selection	12
Initial Inspection	13
Table. Verifying the contents	13
Shipping problems?	14
Test Set Location and Rack Mounting Requirements	14
Turning on the test set the first time	15
Initializing the test set using a USB mouse and external monitor	15
Source Level Accuracy	20
Source Alignment	20
Power Search	20
Options	21
Anti-Virus Software and Firewalls	21
Shortening the Test Set Power-On Time	21
Instrument Information	22
Power requirements	22
Environmental Conditions (Operating)	23
Ventilation	24
Instrument Maintenance	24
Protecting against electrostatic discharge	26

## 2 Front Panel Features

Front-Panel Features	28
Input/Output Hardware Interface	30
Controller Hardware Interface	32
Virtual Front Panel	34
When the Test Set is Controlled Remotely	35

Display Annotations	36
Rear-Panel Features	38
Front and Rear Panel Symbols	39

### 3 Test Set Operating System

Agilent Software Installed	42
Agilent V9060A & V9077A software	42
Customer Installation of Software	43
3rd party software verified by Agilent	43
Installation of other 3rd party software	43
User Accounts	44
Administrator login	44
User login	44
AgilentOnly user account	44
Agilent service user accounts	44
Customer creation of accounts	45
Agilent Licensing Options	46
Fixed Perpetual	46
Transportable Perpetual	46
Time-Limited Licenses	47
Licensing New Measurement Application Software - After Initial Purchase	48
Transporting a License Between Test Sets	50
Windows Configuration	53
Settings that can be changed	53
Settings that must not be changed	54
Configuring Printers	56
Configuring LAN	57
Hostname	57
IP Address & Gateway	57
Windows Security	58
Windows Firewall	59
Automatic updates	59
Virus protection	60
Spyware protection	61
System Maintenance	62
Backup	62
System restore	62

Disk defragmenting	62
USB Connections	63
Hard Drive Partitioning and Use	64
Hard Drive Recovery Process	65
Updating the software	67
Configuring recovery prompt timing	73

## 4 Using Microsoft Windows Operating System

Navigating Windows Without a Mouse	76
Remote Desktop: Using the Sest Set Remotely	77
Overview of Remote Desktop operation	77
Setting up Remote Desktop operation	77
How to locate the computer name of the test set	79
Running a Remote Desktop session	81
The Virtual Front Panel	90
Capturing/Printing Displays and Windows	91
Windows Shortcuts and Miscellaneous Tasks	92
Windows shortcuts (key combinations)	92
Windows taskbar auto-hide feature	93
Windows startup folder	95

## 5 Troubleshooting

Check the Basics	98
Problems with Microsoft Windows Operating System	100
Returning a test set for Service	101
Calling Agilent Technologies	101
Locations for Agilent Technologies	101
Read the Warranty	102
Service Options	102
Packaging the Test Set	103

## Index







# 1 Quick-Start

This section explains how to initialize the test set and generate and view a signal.

The following topics can be found in this section:

“About the Test Set” on page 10

“Initial Inspection” on page 13

“Test Set Location and Rack Mounting Requirements” on page 14

“Turning on the test set the first time” on page 15

“Anti-Virus Software and Firewalls” on page 21

“Shortening the Test Set Power-On Time” on page 21

“Instrument Information” on page 22



## About the Test Set

The E6630A Wireless Connectivity Test Set contains one or two transmit/receive instruments containing an RF source and an RF analyzer. Each instrument is run by its own instance of the XSA firmware application (a fully loaded test set shows two independent XSA windows on its monitor display).

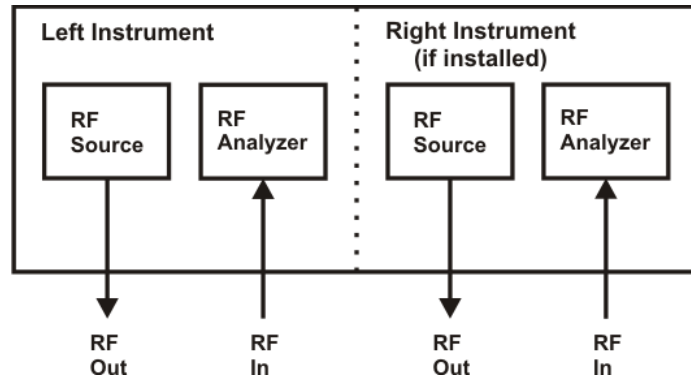

The test set is typically used in conjunction with the E6618A Multiport Adapter, as illustrated below.

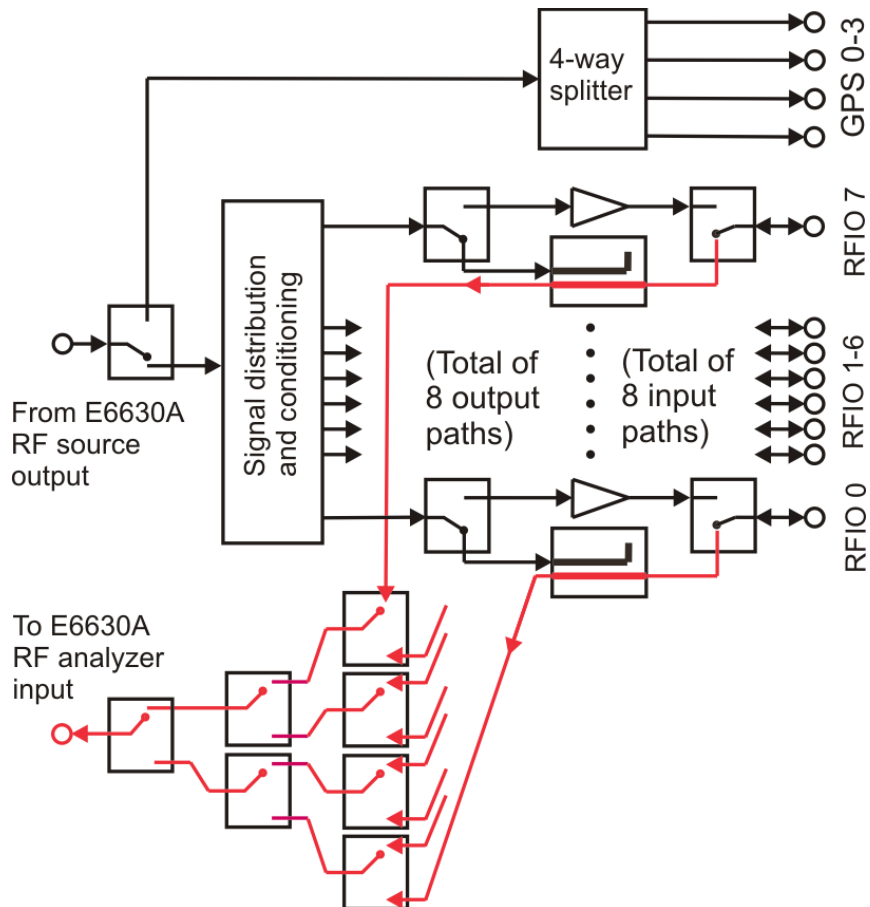

The multiport adapter splits the downlink RF signal from the test set's source into eight RF output paths. All eight output paths can be active at once, or the user can activate a subset of them in any desired combination. Each path interfaces to an RFIO port through a coupler, so that the RFIO port can also return an uplink signal to the analyzer in the test set. (Usually an RFIO port is either an input or an output at any given time, but in LTE-FDD applications it can serve as both at once.) The coupler in the RF output path can be bypassed by a high-power output-only path (this output-only path cannot be selected directly by the user; it is activated automatically, as needed, during LTE-TDD measurements).

Alternatively, the downlink RF signal from the test set's source can be sent through a 4-way splitter to the four GNSS outputs of the multiport adapter. (This path *can* be directly selected by the user.)

Each of the eight RF Uplink RF signals is directed back to the test set through one of the eight selectable RF input paths. Each path leads through a coupler to a set of RF switches, and is returned to the test set's analyzer.

**NOTE**

Downlink and uplink signals are handled slightly differently by the multiport adapter. Downlink signals from the test set's source are split so as to provide a stimulus output to as many as eight ports at the same time. Uplink signals to the test set's analyzer, however, are switched rather than split, and at a given time the analyzer receives an input from only one of the eight RFIO ports of the multiport adapter.

## Instrument Selection

On the monitor or remote desktop view of the test set, each of the two instruments is represented by a separate XSA window. You can identify which TRX a window controls by looking for the identifier (“Left” or “Right”) at the top left corner of the window.

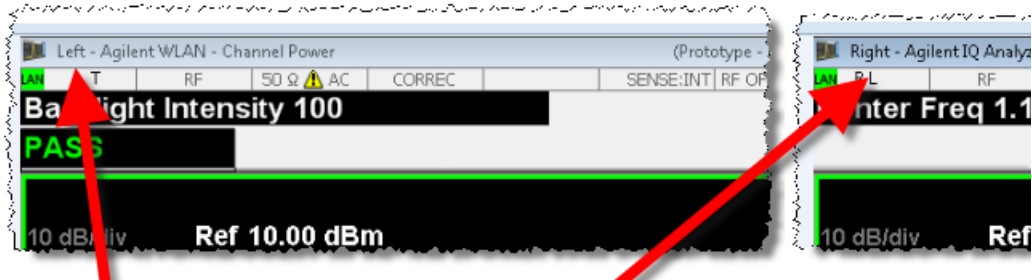

Although the test set as a whole is assigned only one IP address for the entire PXIe chassis, the individual instruments within the chassis can be differentiated in network communication with the test set. For information on how to send commands to the test set, using a VISA connection, see the Agilent E6630A Programmer’s Guide, which is available online at:

[http://www.agilent.com/find/E6630A\\_manuals](http://www.agilent.com/find/E6630A_manuals)

**NOTE**

If the E6630A includes both of the possible sub-instruments, they are controlled using separate VISA connections. By default, the left and right sub-instruments are distinguished by the socket numbers 5025 and 5125, respectively.

Left sub-instrument:

```
TCPIP0::<hostname>::5025::SOCKET
```

Right sub-instrument:

```
TCPIP0::<hostname>::5125::SOCKET
```

## Initial Inspection

Inspect the shipping container and the cushioning material for signs of stress. Retain the shipping materials for future use, as you may wish to ship the test set to another location or to Agilent Technologies for service.

### Verifying the contents

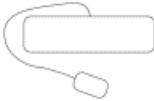
Item	Deliverable	Description
Getting Started Guide		Provides first-time power on instructions, licensing information, operating system information, and general hardware information.
USB keyboard & mouse		A keyboard and mouse for communication with the controller and measurement applications.
Power cable		Connection for test set power.

### Shipping problems?

If the shipping materials are damaged or the contents of the container are incomplete:

- Contact the nearest Agilent Technologies office.
- Keep the shipping materials for the carrier's inspection.
- If you must return a test set to Agilent Technologies, use the original (or comparable) shipping materials. See "Returning a test set for Service" on page 101.

### Test Set Location and Rack Mounting Requirements

#### Locating the test set

Make sure that the fan inlet and exhaust vent areas on the sides of the test set are not obstructed. The minimal required clearance is 2 inches. Airflow restrictions cause additional airflow noise and cause the fans to speed up so they can draw in enough air for the required cooling resulting in excessive audible noise.

#### Cooling and rack mounting

Do not rack mount the test set side-by-side with any other instrument with side-by-side ventilation. Make sure the exhaust air from the first instrument is directed away from the inlet of the second unit. If the pre-heated air from the first instrument is directed into the second instrument, it can cause excessive operating temperatures in the second unit and can cause instrument failures. The test set draws air in from the left side and exhausts air from the right side.

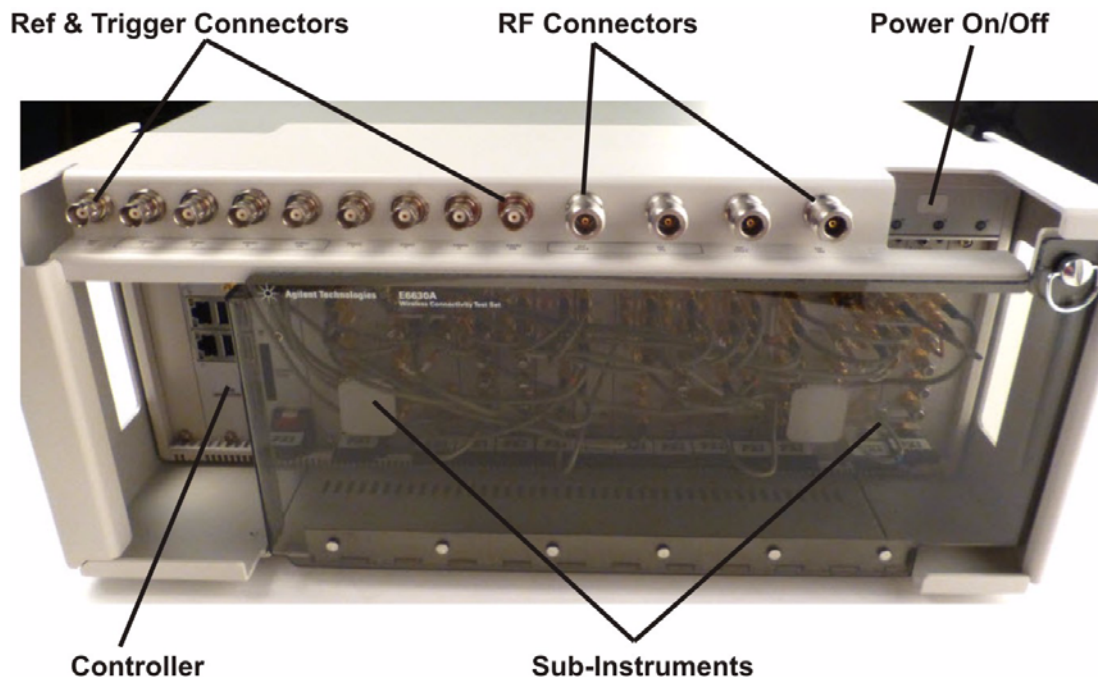

## Turning on the test set the first time

**NOTE**

During the initial power-on process, the test set turns off and restarts several times. This *only* happens during the initial installation process.

### Initializing the test set using a USB mouse and external monitor

Steps	Actions	Notes
1 Connect a mouse and keyboard	<ul style="list-style-type: none"> <li>Connect the mouse and keyboard to two of the USB ports on the front panel of the test set.</li> </ul>	
2 Connect a VGA monitor	<ul style="list-style-type: none"> <li>Connect the monitor to the monitor port on the front panel of the test set.</li> </ul>	<ul style="list-style-type: none"> <li>Model E6630A has no display; an external monitor is required.</li> <li>See “Virtual Front Panel” on page 34.</li> </ul>
3 Power on the test set	<ol style="list-style-type: none"> <li>Position the test set so you have easy access to the power cord and plug it in.</li> <li>Press the power switch (located near the top right corner of the PXI rack) to turn the test set on.</li> </ol>	<ul style="list-style-type: none"> <li>See “Test Set Location and Rack Mounting Requirements” and “Power requirements” on page 22 for more details.</li> <li>The test set can require more than 5 minutes to power-on. This is affected by Windows start-up requirements.</li> <li>The Agilent Technologies screen appears followed by a screen that allows you to select the operating system.</li> </ul> <div data-bbox="854 1230 1143 1444" data-label="Image"> </div> <ul style="list-style-type: none"> <li>At this time, it is safe to turn off the test set before starting the Setup Wizard.</li> </ul>

# 1 Quick-Start

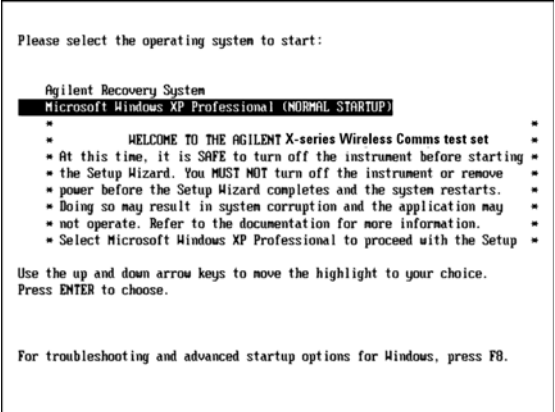
Steps	Actions	Notes
4 Launch Microsoft Setup Wizard	<ul style="list-style-type: none"><li>Highlight Microsoft Windows and press <b>Enter</b> to start the pre-installed operating system.</li></ul>	

- a The analyzer performs the following steps:
  - Windows Startup window
  - Black screen
  - Windows message window, “Please wait while windows prepares to setup”
  - Blue Agilent window
  - The following Welcome window appears giving you information about the End-User License Agreement.



- At this time, it is safe to turn off the instrument before initializing the software.

## CAUTION

After launching the setup, do not turn off the instrument or remove power before the Setup Wizard completes and the system restarts. Turning off the instrument may corrupt the system and the application may not operate.

- |                    |   |   |
|--------------------|---|---|
| 5 Reboot and logon | <ul style="list-style-type: none"><li>a Click <b>OK</b></li></ul> | <ul style="list-style-type: none"><li>When the instrument restarts, the following message window appears:</li></ul> |
|--------------------|---|---|

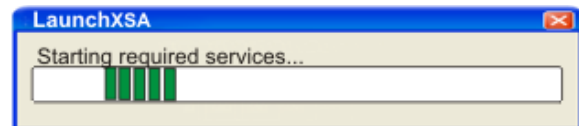



Steps	Actions	Notes
-------	---------	-------

- This window appears and covers the LaunchXSA window.



**NOTE**

If you do not check the “Do not show this message again” check box, this message will be displayed each time the analyzer is turned on. No application will start while this message is displayed. Before continuing, make sure that you carefully read the Anti-Virus message and determine what action is appropriate.

- |   |  |   |
|---|--|---|
| <p>6 Disable the Anti-Virus message</p> | <p>a Select the check box and click <b>Continue</b>.</p> | <ul style="list-style-type: none"> <li>• Messages similar to the following continue to appear:</li> </ul> |
|---|--|---|

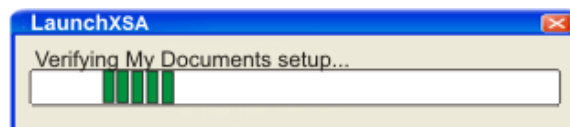

- The system reboots.
- Several required processes continue.
- The system reboots.
- The XSA application initializes

- 7 If two sub-instruments are installed in the PXI rack, two instances of the application are launched; they are identified as “Left” and “Right” in the application windows. The verification procedures which follow should be done for both.

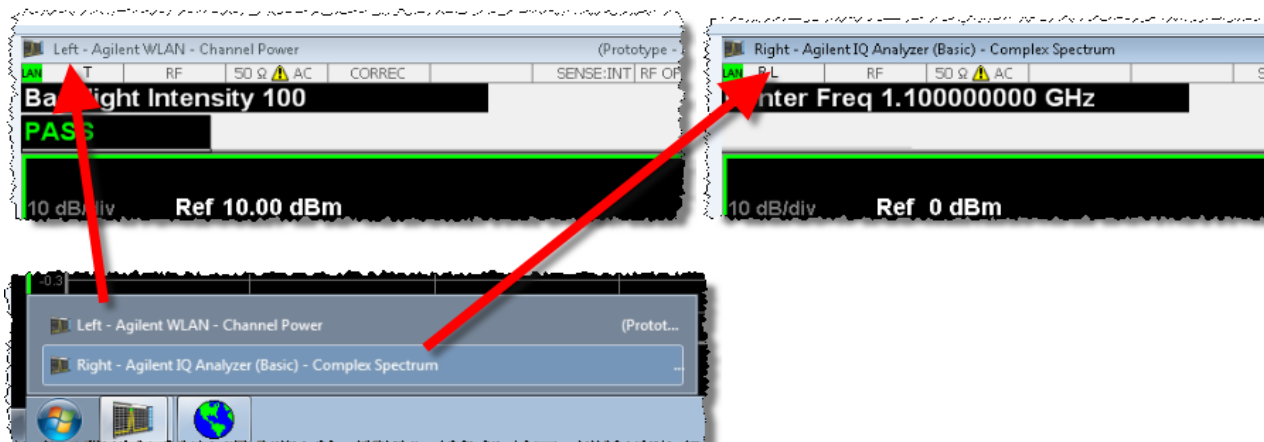

## 1 Quick-Start

Steps	Actions	Notes
8 Verify the installation	<p><b>a</b> From the mouse right-click menu, select <b>Utility, Virtual Front Panel</b>. (All key-presses that follow refer to the keys shown on the Virtual Front Panel.)</p> <p><b>b</b> Press <b>System, Show, System</b>.</p> <p><b>c</b> Verify that the purchased application(s) appear in the list.</p>	<ul style="list-style-type: none"><li>• If you require further assistance, contact the Agilent support team. Online assistance: <a href="http://www.agilent.com/find/assist">http://www.agilent.com/find/assist</a></li></ul>
9 Attach a loopback cable	<p><b>a</b> Use an RF cable to connect the front panel RF In and RF Out ports for this sub-instrument.</p>	<ul style="list-style-type: none"><li>• The purpose is to use a loopback cable to verify that the test set's source can generate a signal and the test set's analyzer can measure it.</li></ul>
10 Generate and view a signal	<p><b>a</b> Press <b>Input/Output, More, RF Output &amp; Test Set Config, RF Output, RF Output</b>.</p> <p><b>b</b> Press <b>AMPTD Y Scale, Ref Value, 10, dBm</b>.</p> <p><b>c</b> Press <b>FREQ, Center Freq, 2.4, GHz</b>.</p> <p><b>d</b> Press <b>SPAN X Scale, Span, 8, MHz</b>.</p> <p><b>e</b> Press <b>Source, Frequency, 2.4, GHz</b>.</p> <p><b>f</b> Press <b>Source, RF Output, On</b>.</p> <p><b>g</b> Press <b>Source, Amplitude, RF Power, 0, dBm</b>.</p>	<ul style="list-style-type: none"><li>• Select RF Output rather than GPS Output.</li><li>• Set the amplitude reference to 10 dBm</li><li>• Set the analyzer center frequency to 2.4 GHz.</li><li>• Set the analyzer span to 8 MHz.</li><li>• Set the source frequency to 2.4 GHz.</li><li>• Set the source RF output to On.</li><li>• Set the source amplitude to 0 dBm.</li><li>• To ensure accurate power levels from the source, see "Source Level Accuracy" on page 20.</li></ul>

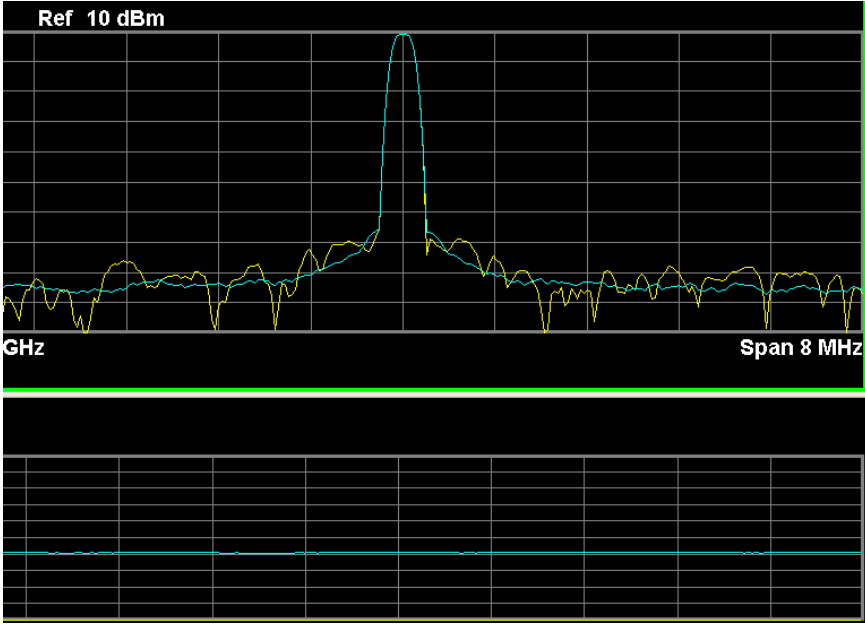
Steps	Actions	Notes
	The 2.4 GHz signal appears on the display.	
		
11	If an E6618A Multiport Adapter will be used, connect the E6618A hardware.	Procedures for connecting the E6618A Multiport Adapter to the E6630A Test Set are presented in the Started Guide for the E6618A.

# Source Level Accuracy

To ensure accurate power levels from the Vector Signal Generator, two adjustments need to be run; they are known as Source Alignment and Power Search.

## Source Alignment

This alignment is needed when you change the source output frequency, and also when the instrument's internal temperature has drifted more than 4 degrees C since the alignment was last performed (temperature can be checked by sending a SCPI command (:CAL:TEMP:CURR?).

The alignment is not run automatically by the test set, nor does it run at power-up, nor is it run in response to **System > Alignments > Align Now > All**. The alignment must be called explicitly, as described below. (However, the alignment data is saved and survives a power cycle.)

To run the source alignment, select **System > Alignments > Align Now > Source**, or send the SCPI command :CAL:INT:SOUR. The alignment takes approximately two seconds to run.

## Power Search

The power search feature provides a means to control source power when ALC is off (which is sometimes needed for burst signals).

To run the source power search, select **Source > Amplitude > Do Power Search**, or send the SCPI command :SOURce:POWer:ALC:SEARCh. This takes very little time to run (typically below 1 ms).

## Options

The options installed on the test set are listed on the **System > Show > System** display.

## Anti-Virus Software and Firewalls

No anti-virus software is shipped with the test set. It is recommended that you install anti-virus software if your test set is connected to the LAN. Check with your IT department to see what they recommend.

The test set is shipped with the Windows firewall enabled. Do not modify the default network settings as this may cause problems with the operating system of the test set.

## Shortening the Test Set Power-On Time

The test set desktop includes a shortcut to the ConfigureApplications.exe application that lets you control your test set power-on configuration. You can set the configuration to pre-load only the applications that you typically run. This can significantly shorten the time it takes for your test set to power-on. You can also access this functionality by pressing: **System, Power On, Configure Applications**. (These key-presses refer to the Virtual Front Panel; see "Virtual Front Panel" on page 34.)

If (after power-on) you want to access an application that you did not pre-load, it will take a little longer to bring it up once you press the application softkey. This longer time-frame is only for the first access after power-on. After the initial access, mode (application) switching will operate as quickly as if the application was pre-loaded.

## Instrument Information

### Power requirements

The only physical installation of your Agilent test set is a connection to a power source. Line voltage does not need to be selected.

This test set does *not* contain customer serviceable fuses.

#### WARNING

**This is a Safety Class 1 Product (provided with a protective earthing ground incorporated in the power cord). The mains plug shall only be inserted in a socket outlet provided with a protective earth contact. Any interruption of the protective conductor inside or outside of the product is likely to make the product dangerous. Intentional interruption is prohibited. (IEC 348 clauses 17.3.3c & 17.3.4)**

**Failure to ground the test set properly can result in personal injury. Before turning on the test set, you must connect its protective earth terminals to the protective conductor of the main power cable. Insert the main power cable plug into a socket outlet that has a protective earth contact only. DO NOT defeat the earth-grounding protection by using an extension cable, power cable, or autotransformer without a protective ground conductor.**

---

#### CAUTION

This product is designed for use in Installation Category II and Pollution Degree 2 per IEC 61010 Second Edition and IEC 664 respectively. This instrument has autoranging line voltage input. Before switching on the instrument, be sure the supply voltage is within the specified range.

The Mains wiring and connectors shall be compatible with the connector used in the premise electrical system. Failure, to ensure adequate earth grounding by not using the correct components may cause product damage, and serious injury.

---

## AC power cord

The test set is equipped with a three-wire power cord, in accordance with international safety standards. This cable grounds the test set cabinet when connected to an appropriate power line outlet. The cable appropriate to the original shipping location is included with the test set. See:

<http://www.agilent.com/find/powercords>

### CAUTION

Always use the three-prong AC power cord supplied with this product. Failure to ensure adequate earth grounding by not using this cord can cause product damage.

This instrument has auto-ranging line voltage input; be sure the supply voltage is within the specified range and voltage fluctuations do not to exceed 10 percent of the nominal supply voltage:

100/120 VAC 50/60 Hz, 1000 W MAX

220/240 VAC 50/60 Hz, 1200 W MAX.

### WARNING

**If this product is not used as specified, the protection provided by the equipment could be impaired. This product must be used in a normal condition (in which all means for protection are intact) only.**

**Install the instrument so that the detachable power cord is readily identifiable and easily reached by the operator. The detachable power cord is the instrument disconnecting device. It disconnects the mains circuits from the mains supply before other parts of the instrument. The front panel switch is only a standby switch and is not a LINE switch. Alternatively, an externally installed switch or circuit breaker (which is readily identifiable and is easily reached by the operator) may be used as a disconnecting device.**

## Environmental Conditions (Operating)

This product is designed for use in the following conditions:

- For indoor use only
- Altitude up to 3000 meters
- Maximum relative humidity 80% for temperatures up to 31 degrees C, decreasing linearly to 50% relative humidity at 40 degrees C.

### CAUTION

This product is designed for use in Installation Category II and Pollution Degree 2 per IEC 61010 Second Edition and IEC 664 respectively.

## Ventilation

**CAUTION**

**VENTILATION REQUIREMENTS:** When installing the product in a cabinet, the convection into and out of the product must not be restricted. The ambient temperature (outside the cabinet) must be less than the maximum operating temperature of the product by 4°C for every 100 watts dissipated in the cabinet. If the total power dissipated in the cabinet is greater than 800 watts, then forced convection must be used.

---

## Instrument Maintenance

### Cleaning the instrument

**WARNING**

To prevent electrical shock, disconnect the test set from mains before cleaning. Use a dry cloth or one slightly dampened with water to clean the external case parts. Do not attempt to clean internally.

---

### Cleaning the connectors

**WARNING**

Cleaning connectors with alcohol shall only be done with the instrument power cord removed, and in a well-ventilated area. Allow all residual alcohol moisture to evaporate, and the fumes to dissipate prior to energizing the instrument.

---

### Battery Information

The test set uses a lithium battery located on the CPU board. This is not an operator replaceable part. See “[Returning a test set for Service](#)” on page 101. Replaceable parts must be approved or supplied by Agilent Technologies.

You can order the service documentation for the instrument through your Agilent Sales and Service office.

**WARNING**

**Danger of explosion if battery is incorrectly replaced. Replace only with the same or equivalent type recommended. Discard used batteries according to the manufacturer’s instructions.**

**Do not throw batteries away but collect as small chemical waste.**

---



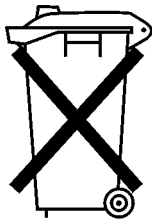

DO NOT THROW BATTERIES AWAY BUT  
COLLECT AS SMALL CHEMICAL WASTE.

### Protecting against electrostatic discharge

Electrostatic discharge (ESD) can damage or destroy electronic components (the possibility of unseen damage caused by ESD is present whenever components are transported, stored, or used).

#### Test equipment and ESD

To help reduce ESD damage that can occur while using test equipment:

**WARNING**

**Do not use these first three techniques when working on circuitry with a voltage potential greater than 500 volts.**

---

- Before connecting any coaxial cable to a test set connector for the first time each day, momentarily short the center and outer conductors of the cable together.
- Personnel should be grounded with a 1 M $\Omega$  resistor-isolated wrist-strap before touching the center pin of any connector and before removing any assembly from the test set.
- Be sure that all instruments are properly earth-grounded to prevent build-up of static charge.
- Perform work on all components or assemblies at a static-safe workstation.
- Keep static-generating materials at least one meter away from all components.
- Store or transport components in static-shielding containers.
- Always handle printed circuit board assemblies by the edges. This reduces the possibility of ESD damage to components and prevent contamination of exposed plating.

#### Additional information about ESD

For more information about ESD and how to prevent ESD damage, contact the Electrostatic Discharge Association (<http://www.esda.org>). The ESD standards developed by this agency are sanctioned by the American National Standards Institute (ANSI).

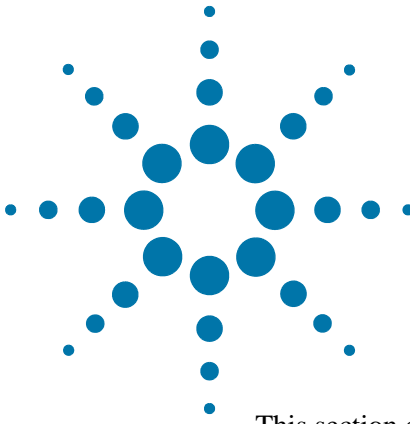

## 2 Front Panel Features

This section describes the following features:

“Front-Panel Features” on page 28

“Display Annotations” on page 36

“Rear-Panel Features” on page 38

“Front and Rear Panel Symbols” on page 39



## Front-Panel Features

The test set consists of instruments loaded in a PXI rack. There is a controller (located on the far left) and one or two sub-instruments, which are protected by a translucent impact cover and are not exposed during normal operation. A hardware interface at the top of the rack provides access to inputs and outputs for RF and trigger signals.

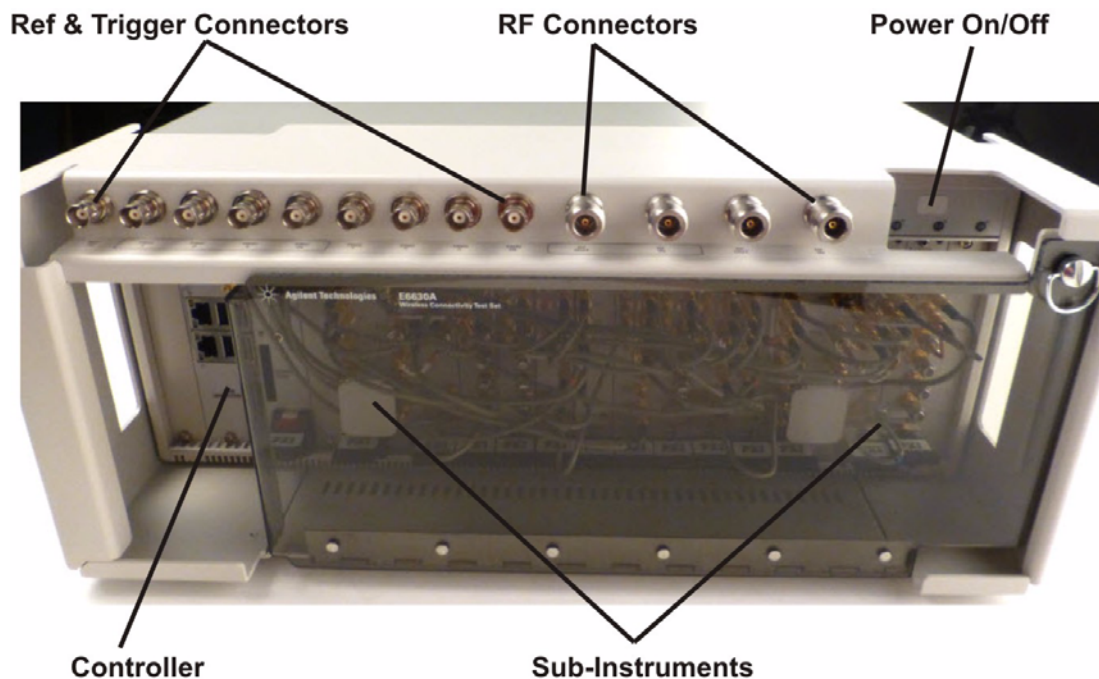

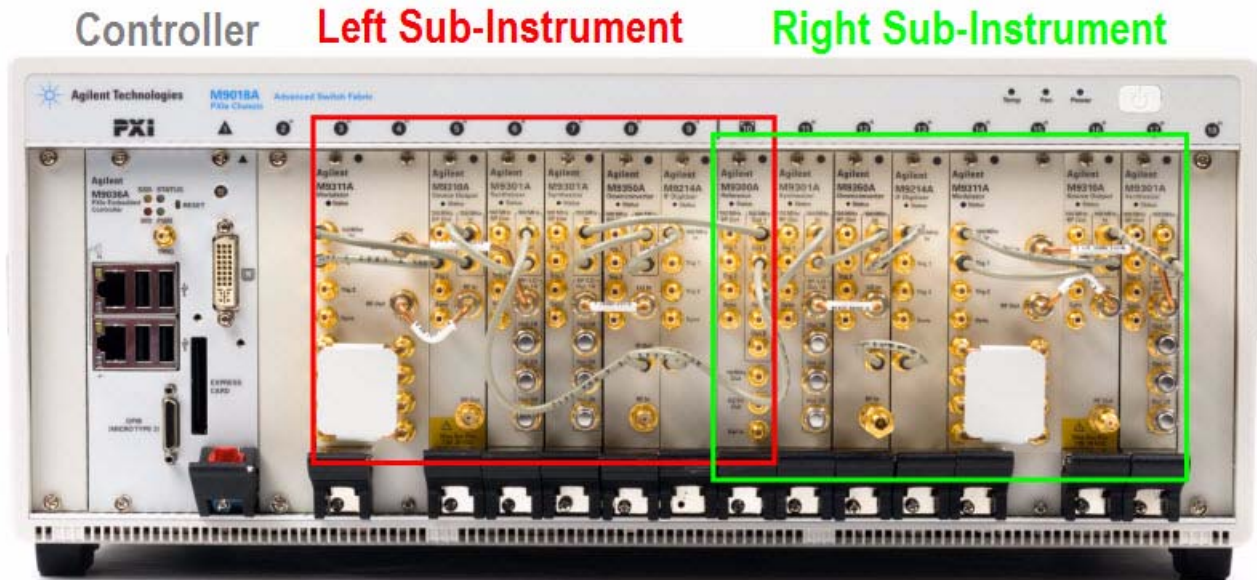

Each of the sub-instruments under the impact cover includes a Vector Signal Generator (M9381A) and a Vector Signal Analyzer (M9391A). If both sub-instruments are installed, they share the Controller (M9036A) and a common Frequency Reference (M9300A).

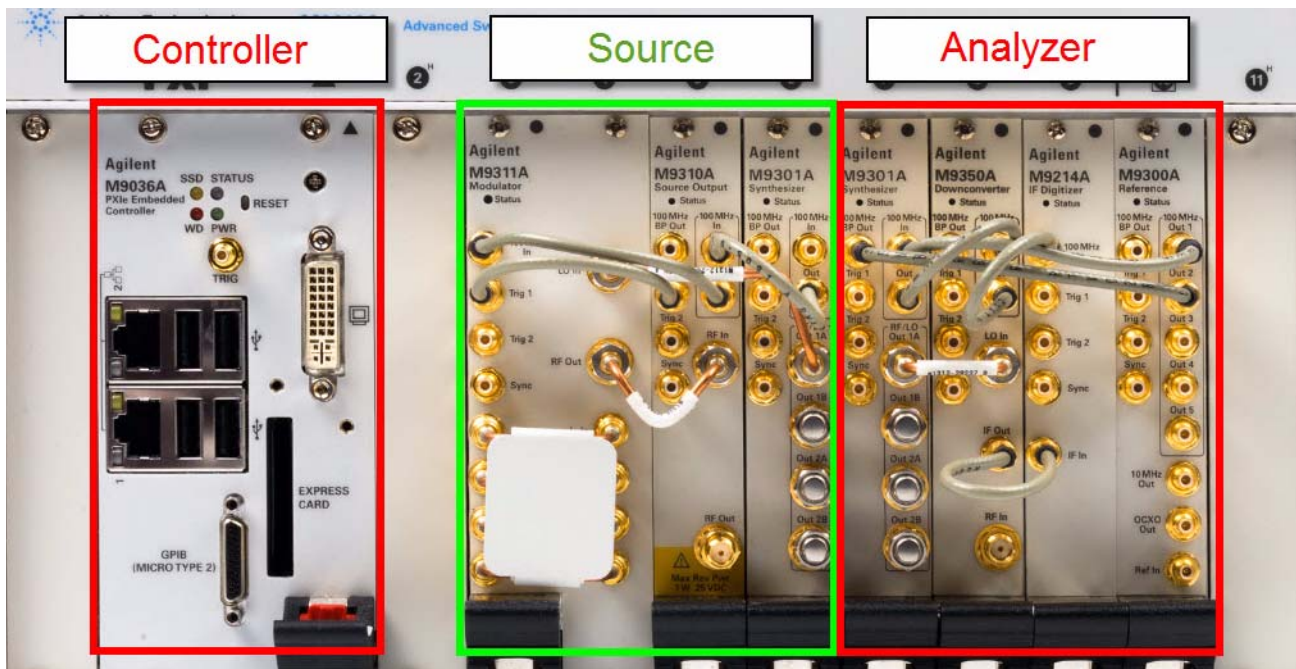



## Input/Output Hardware Interface

The connectors which are exposed when the impact cover is in place are illustrated below:

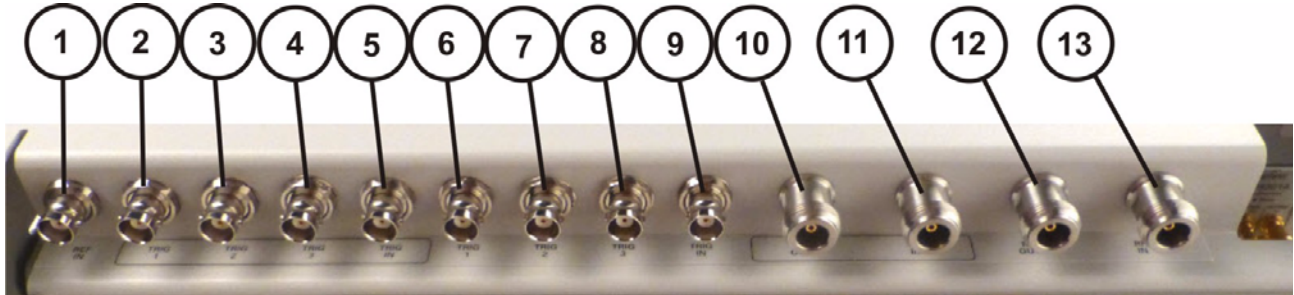

Item		Description
#	Name	
1	REF IN	This BNC input port accepts a timebase reference input. Under the impact cover, it is routed to the Ref In port of the M9300A Reference module.
2	TRIG 1	This BNC trigger port (for the left sub-instrument) is used for output triggers from the analyzer. Under the impact cover, it is routed to the Trig 2 port of the M9214A IF Digitizer module.
3	TRIG 2	This BNC trigger port (for the left sub-instrument) is used for input or output triggers to or from the source. Under the impact cover, it is routed to the Trig 2 port of the M9311A Modulator module.
4	TRIG 3	This BNC trigger port (for the left sub-instrument) is an RF blanking trigger which is supplied to the TRIG 3 port on the E6618A Multiport Adapter. Under the impact cover, it is routed to the Trig 2 port of the M9310A Source Output module.
5	TRIG IN	This BNC trigger port (for the left sub-instrument) accepts an external trigger input to the analyzer. Under the impact cover, it is routed to the Trig 1 port of the M9214A IF Digitizer module.
6	TRIG 1	This BNC trigger port (for the right sub-instrument) is used for output triggers from the analyzer. Under the impact cover, it is routed to the Trig 2 port of the M9214A IF Digitizer module.
7	TRIG 2	This BNC trigger port (for the right sub-instrument) is used for input or output triggers to or from the source. Under the impact cover, it is routed to the Trig 2 port of the M9311A Modulator module.
8	TRIG 3	This BNC trigger port (for the right sub-instrument) is an RF blanking trigger which is supplied to the TRIG 3 port on the E6618A Multiport Adapter. Under the impact cover, it is routed to the Trig 2 port of the M9310A Source Output module.

Item		Description
#	Name	
9	TRIG IN	This BNC trigger port (for the right sub-instrument) accepts an external trigger input to the analyzer. Under the impact cover, it is routed to the Trig 1 port of the M9214A IF Digitizer module.
10	RF OUT	This Type N RF output port (for the left sub-instrument) is connected to the DUT or to RF IN on the E6618A Multiport Adapter.
11	RF IN	This Type N RF input port (for the left sub-instrument) is connected to the DUT or to RF OUT on the E6618A Multiport Adapter.
12	RF OUT	This Type N RF output port (for the right sub-instrument) is connected to the DUT or to RF IN on the E6618A Multiport Adapter.
13	RF IN	This Type N RF input port (for the right sub-instrument) is connected to the DUT or to RF OUT on the E6618A Multiport Adapter.

## Controller Hardware Interface

The controller is exposed even when the impact cover is in place. The connectors are illustrated below:

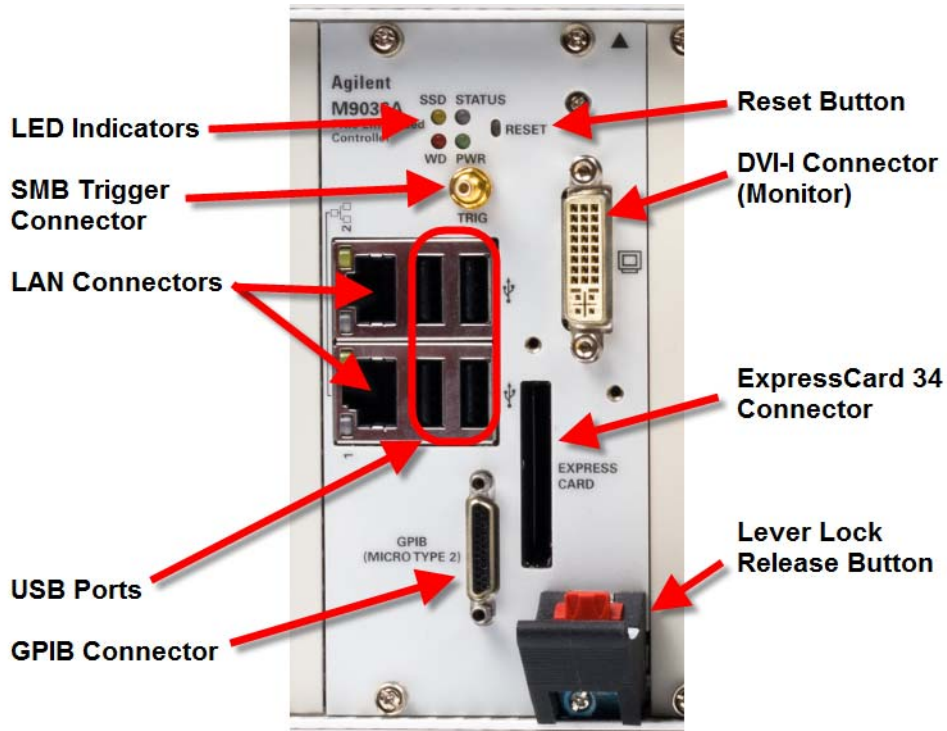

Item Name	Description
LED Indicators	<ul style="list-style-type: none"> <li>SSD (yellow): flashes when Solid State Drive (SSD) is active.</li> <li>STATUS (blue): if the LED is on and then turns off during system boot, then the system status is normal. If the LED continues blinking or stays on, it indicates the system is not able to shut down properly. When the chassis Inhibit switch is in the Manual position, a controller shutdown results in an operating system shutdown; however, the controller is not able to shut down the chassis power supply. As a result, the LED remains on until the Inhibit pin is pulsed low (thus cycling the power supply) OR the chassis power button is pressed again causing the operating system to reboot.</li> <li>WD (red): not significant on this model, but bus activity may cause it to light.</li> <li>PWR (green): if the LED is on, the power supply to the controller is good and the system should boot.</li> </ul>
SMB Trigger Connector	This trigger line is not used by the E6630A.

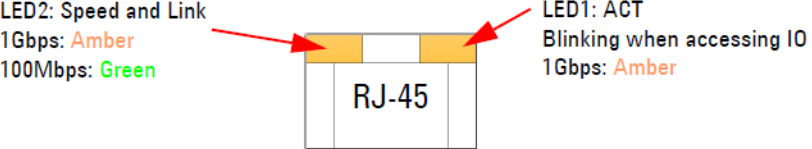

Item Name	Description																	
LAN Connectors	<p>Gigabit Ethernet (GbE) LAN: two RJ-45 connectors with speed/link/active LED on the faceplate. Connectors include embedded LEDs:</p> <p><b>Gigabit Ethernet (GbE) connector LED</b></p> <p>LED2: Speed and Link                      1Gbps: <b>Amber</b>                      100Mbps: <b>Green</b></p>  <p>LED1: ACT                      Blinking when accessing IO                      1Gbps: <b>Amber</b></p> <table border="1" data-bbox="599 615 1318 997"> <thead> <tr> <th>LED</th> <th>Status</th> <th>Description</th> </tr> </thead> <tbody> <tr> <td rowspan="3">Active/Link LED (yellow)</td> <td>Off</td> <td>Ethernet port is disconnected</td> </tr> <tr> <td>On</td> <td>Ethernet port is connected but no data transmission</td> </tr> <tr> <td>Flash</td> <td>Ethernet port is connected and is transmitting/receiving data</td> </tr> <tr> <td rowspan="3">Speed LED</td> <td>Off</td> <td>10Mbps</td> </tr> <tr> <td>Green</td> <td>100Mbps</td> </tr> <tr> <td>Amber</td> <td>1000Mbps</td> </tr> </tbody> </table>	LED	Status	Description	Active/Link LED (yellow)	Off	Ethernet port is disconnected	On	Ethernet port is connected but no data transmission	Flash	Ethernet port is connected and is transmitting/receiving data	Speed LED	Off	10Mbps	Green	100Mbps	Amber	1000Mbps
LED	Status	Description																
Active/Link LED (yellow)	Off	Ethernet port is disconnected																
	On	Ethernet port is connected but no data transmission																
	Flash	Ethernet port is connected and is transmitting/receiving data																
Speed LED	Off	10Mbps																
	Green	100Mbps																
	Amber	1000Mbps																
USB Ports	<p>The controller provides four USB 2.0 Type A ports on the faceplate. All USB ports are compatible with high-speed, full-speed and low-speed USB devices. The controller supports multiple boot devices. The boot priority and boot device can be configured in BIOS. USB to VGA display adapters are supported.</p>																	
GPIB Connector	<p>The GPIB connector on controller is a micro D-sub 25P connector. It is not used to control the E6630A; and is not needed in normal operation of the test set. However, it can be used to control external bench-top instruments. You need the supplied GPIB adapter cable to connect instruments. The on-board GPIB controller is compatible with the IEEE 488 standard.</p>																	
Reset Button	<p>If it becomes necessary to perform a hard reset of the controller, you can use any pin-shaped object (such as an unfolded paper clip) to press the front panel reset button.</p>																	
DVI-I Connector	<p>The DVI-I connector connects the controller to a video monitor. DVI-I supports both digital (DVI) and analog (VGA) monitors. While connecting to an analog (VGA) monitor, you need to install the DVI-to-VGA adapter, which is shipped with the M9036A controller, on the DVI-I connector. DVI-I contains both the digital and analog connections, (DVI-D and DVI-A), it's essentially a combination of DVI-D and DVI-A video output within one connector (and cable). The DVI-I output provides up to 1920x 1200 60 Hz resolution or up to 2048 x 1536 at 75Hz resolution.</p>																	
Express Card	<p>The Express Card 34 slot is not used in operation of the E6630A test set; however, it is available for use as an I/O expansion accessory.</p>																	
Lever Lock Release Button	<p>Press the red button down before moving the black ejector/injector handle.</p>																	

## Virtual Front Panel

The E6630A model does not include physical front-panel keys. However, if you have a PC mouse, monitor, and keyboard plugged in (or are working through a Remote Desktop interface), you can navigate front-panel functions using the virtual front panel (VFP) shown below. Access the VFP as follows:

1. Right-click the mouse.
2. Left-click Utility (1) in the menu, as shown below.
3. Left-click Virtual Front Panel (2) in the menu, as shown below.

**NOTE**

The PC mouse and monitor are required when using the E6630A. For ease in using the VFP, the PC keyboard is recommended.

:

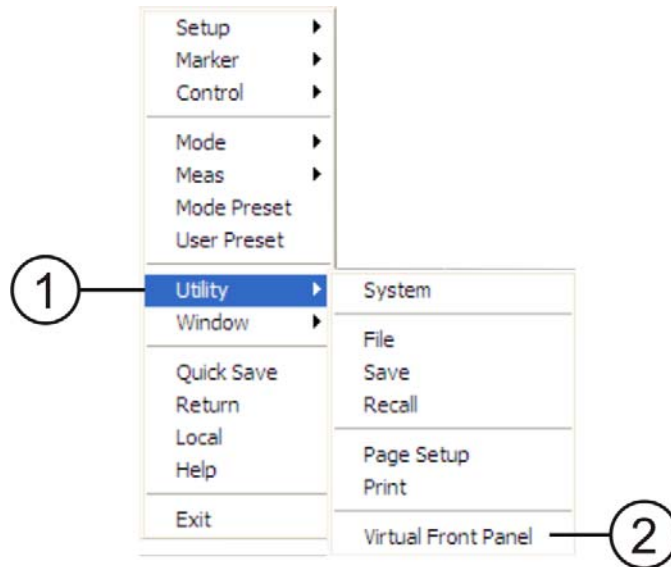

On the VFP the keys labeled "Key 1" through "Key 7" function as the menu keys. Using the mouse to click on a combination of the VFP keys and the menu keys on the display screen, you can operate the instrument as if it had conventional front-panel keys. The VFP frame shows "Left" or "Right" at the upper left corner of the frame, so that it's clear which sub-instrument within the PXI rack is being controlled by it.



## When the Test Set is Controlled Remotely

The test set can be controlled remotely, from another computer. (See “Remote Desktop: Using the Sest Set Remotely” on page 77.) When the test set is being controlled remotely, a log-on screen is displayed on the monitor.



Under these circumstances, pressing the front-panel Power switch does not immediately turn instrument power off. Instead, the following message appears:

Other people are logged on to this computer. Shutting down windows might cause them to lose data. Do you want to continue shutting down?

Pressing and holding down the Power button will force a power shutdown.

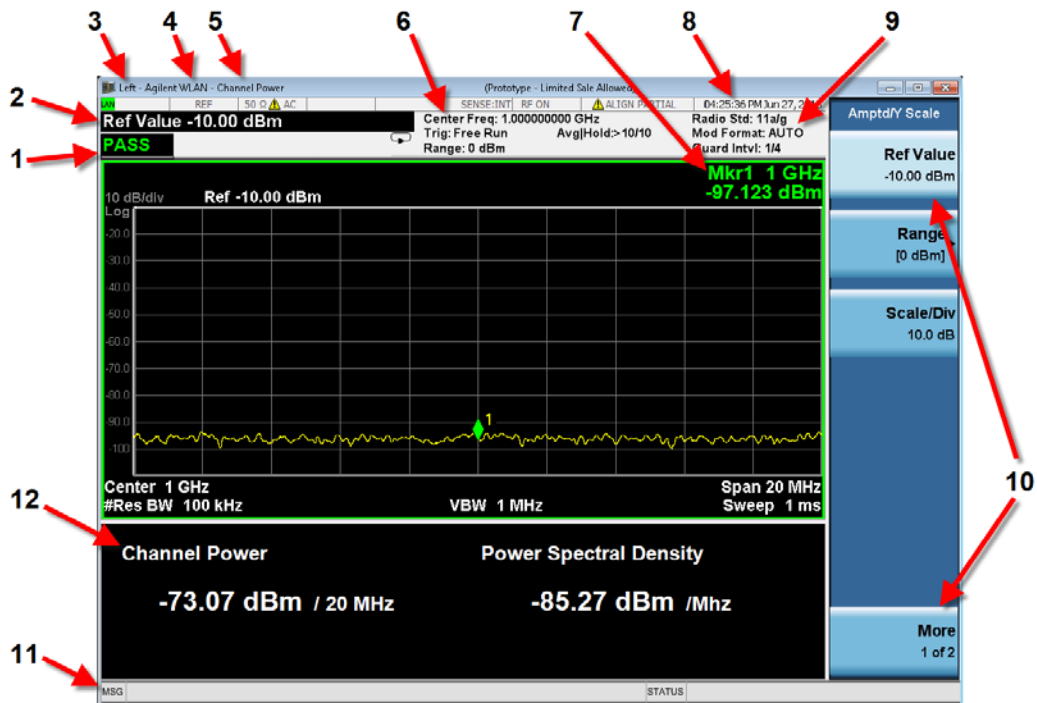
### Display Annotations



Item		Function Key
#	Description	
1	Measurement bar; shows general measurement settings and information. Some measurements include limits which the data is tested against. A Pass/Fail indication may be shown in the lower-left corner. The following graphics indicate single/continuous measurement:   	All the keys in the test set Setup part of the front panel.
2	Active Function (measurement bar); when the current active function has a settable numeric value, it is shown here.	Currently selected front panel key.
3	Sub-instrument associated with the application (identified as “Left” or “Right”). This is needed because the E6630A can include two independent test sets in one PXI rack.	
4	Banner; shows the name of the selected application that is currently running.	<b>Mode</b>
5	Measurement title; shows title information for the current measurement, or a title that you created for the measurement.	<b>Meas View/Display, Display, Title</b>

Item		Function Key
#	Description	
6	<p>Settings panel; displays system information that is not specific to any one application.</p> <ul style="list-style-type: none"> <li>• Input/Output status - green LXI indicates the LAN is connected. RLTS indicate Remote, Listen, Talk, SRQ</li> <li>• Input impedance and coupling</li> <li>• Selection of external frequency reference</li> <li>• Setting of automatic internal alignment routine</li> </ul>	<b>Local and System, I/O Config, Input/Output, Amplitude, System, and others</b>
7	Active marker frequency, amplitude, or function value	<b>Marker</b>
8	Settings panel; time and date display	<b>System, Control Panel</b>
9	Trace and detector information	<b>Trace/Detector, Clear Write (W) Trace Average (A) Max Hold (M) Min Hold (m) Trace/Detector, More, Detector, Average (A) Normal (N) Peak (P) Sample (S) Negative Peak (p)</b>
10	Key labels that change based on the most recent key press	Softkeys
11	Displays information, warning, and error messages. Message area: single events. Status area: conditions.	
12	Measurement settings for the data currently being displayed in the graticule area. In the example above: center frequency, resolution bandwidth, video bandwidth, frequency span, sweep time and number of sweep points.	Keys in the test set Setup part of the front panel.

## Rear-Panel Features

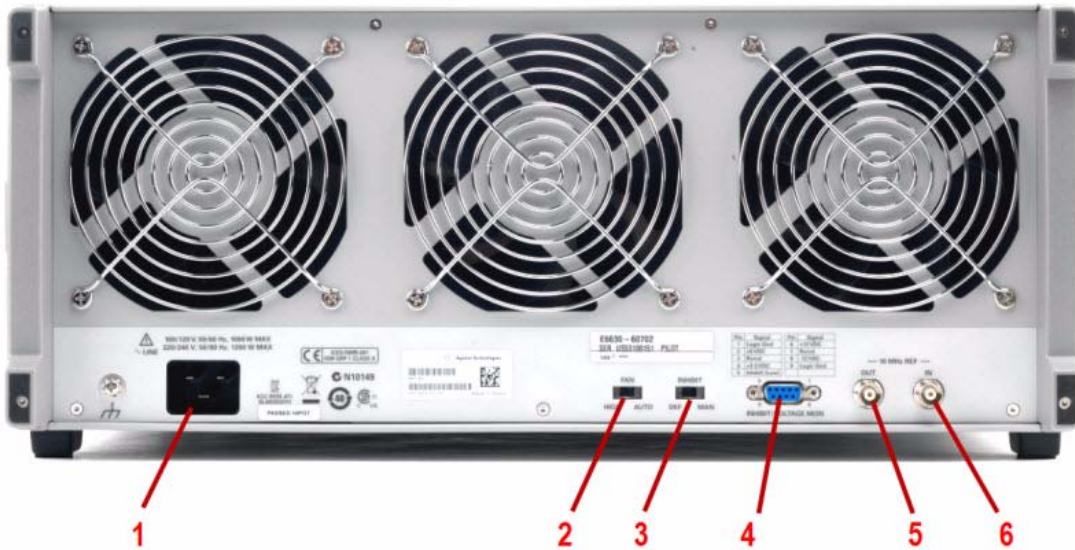

Item		Description
#	Name	
1	Line power input	The AC power connection. See the product specifications for more details.
2	FAN	Fan speed control (settings are HIGH and AUTO).
3	INHIBIT	Inhibit switch. The settings are DEF (default) and MAN (manual). <ul style="list-style-type: none"> <li>When the switch is in the default position, the chassis is powered up by the front panel ON/Standby pushbutton. This is the recommended setting.</li> <li>When the switch is in the manual position, the chassis is powered up by the Inhibit input signal on the rear panel INHIBIT/VOLTAGE MON DB-9 connector.</li> </ul>
4	INHIBIT/ VOLTAGE MON	This DB-9 connector provides access for testing of internal power supply voltages. The voltages (by Pin #) are: (1) Logic Gnd, (2) +5 VDC, (3) Rsrvd, (4) +3.3 VDC, (5) Inhibit [Low], (6) +12 VDC, (7) Rsrvd, (8) -12 VDC, (9) Logic Gnd.
5	10 MHz REF OUT	This BNC connector provides an output of the test set's internal 10 MHz frequency reference signal. It is used to lock the frequency reference of other test equipment to the test set.
6	10 MHz REF IN	This BNC connector accepts an external 10 MHz frequency reference signal. It is used to lock the test set to the frequency reference of other test equipment.

## Front and Rear Panel Symbols

	This symbol is used to indicate power ON (green LED).
⏻	This symbol is used to indicate power STANDBY mode (yellow LED).
~	This symbol indicates the input power required is AC.
⚠	The instruction documentation symbol. The product is marked with this symbol when it is necessary for the user to refer to instructions in the documentation.
CE	The CE mark is a registered trademark of the European Community.
C N10149	The C-Tick mark is a registered trademark of the Australian Spectrum Management Agency.
ICES/NMB-001 ISM GRP.1 CLASS A	This is a marking of a product in compliance with the Canadian Interference-Causing Equipment Standard (ICES-001). This is also a symbol of an Industrial Scientific and Medical Group 1 Class A product (CISPR 11, Clause 4).
SA C US	The CSA mark is a registered trademark of the Canadian Standards Association International.
KC KCC-REM-ATI- 13WTESTF01	<p><b>South Korean Class A EMC Declaration</b> A 급 기기 ( 업무용 방송통신기자재 ) 이 기기는 업무용 (A 급) 전자파적합기기로서 판매자 또는 사용자는 이 점을 주의하시기 바라 며, 가정외의 지역에서 사용하는 것을 목적으로 합니다.</p> <p><b>This equipment is Class A suitable for professional use and is for use in electromagnetic environments outside of the home.</b></p>
♻	This symbol indicates separate collection for electrical and electronic equipment mandated under EU law as of August 13, 2005. All electric and electronic equipment are required to be separated from normal waste for disposal (Reference WEEE Directive 2002/96/EC).
40	Indicates the time period during which no hazardous or toxic substance elements are expected to leak or deteriorate during normal use. Forty years is the expected useful life of the product.
♻	This symbol on all primary and secondary packaging indicates compliance to China standard GB 18455-2001.

To return unwanted products, contact your local Agilent office, or see <http://www.agilent.com/environment/product/> for more information.

## 2 Front Panel Features





## 3 Test Set Operating System

This chapter describes the Microsoft Windows configuration and the settings used with the Agilent test set software. It includes information about changing some of the system settings. And it describes the Windows operating system configuration and the software installations that are present on the hard disk drive when the test set leaves the factory.

“Agilent Software Installed” on page 42

“Customer Installation of Software” on page 43

“User Accounts” on page 44

“Agilent Licensing Options” on page 46

“Licensing New Measurement Application Software - After Initial Purchase” on page 48

“Windows Configuration” on page 53

“Configuring Printers” on page 56

“Configuring LAN” on page 57

“Windows Security” on page 58

“System Maintenance” on page 62

“USB Connections” on page 63

“Hard Drive Partitioning and Use” on page 64

“Hard Drive Recovery Process” on page 65

“Updating the software” on page 67



## Agilent Software Installed

### Agilent V9060A & V9077A software

The Agilent V9060A IQ Analyzer application and the Agilent V9077A WLAN measurement applications (802.11a/b/g, 802.11n, and 802.11ac) are installed by default in the test set, but these must be licensed in order to be used. Whichever licenses were purchased with the instrument are installed at the factory (for example, V9077A-2FP, V9077A-3FP, V9077A-4FP). Other licenses can be purchased and installed later (including transportable licenses, such as V9077A-2TP, V9077A-3TP, V9077A-4TP).

## Customer Installation of Software

### 3rd party software verified by Agilent

Agilent has verified that the following programs are compatible with the test set applications:

- Symantec AntiVirus™ Corporate Edition version 10
- MathWorks MATLAB

### Installation of other 3rd party software

The E6630A platform is an open Windows environment, so you can install non-approved software on the test set. However, installation of non-approved software may affect test set performance. Agilent does not warrant the performance of the test set with non-approved software installed.

**NOTE**

Before installing any additional programs on the test set, you should exit the test set application.

Also, you must not remove any applications or programs that are installed on the test set when it is shipped from the factory.

---

If you install programs other than those that Agilent has tested, it could cause problems with the test set's applications. If this happens, you should try uninstalling the program that has caused the problem, or try changing the program's configuration. If this does not correct the problem, you may have to use the Agilent Recovery system to reinstall the test set's system software.

## User Accounts

### Administrator login

The Administrator account ships from the factory with the password “agilent4u”. Using the Administrator account you can perform the following operations:

- Install software
- Configure network and printer access
- Access all files on the test set
- Add or change user accounts and passwords
- Change Windows settings
- Run any application

### User login

The default user account that ships from the factory is “Instrument” with the password “measure4u”. This user is a member of the Power Users group. Using the Instrument account you can perform the following operations:

- Install software
- Configure network and printer access
- Access files on the test set that are accessible to the Power Users group
- Run applications that are accessible to the Power Users group

### AgilentOnly user account

The test set contains a user account called “AgilentOnly” that can be used by Agilent’s customer support in the event that the Administrator password was changed and has since been lost or forgotten. You must not remove or modify the AgilentOnly account.

### Agilent service user accounts

User accounts are defined for Agilent’s use if it is necessary to service the test set.

## Customer creation of accounts

You can create additional user accounts and decide on the level of security granted to any new user accounts created. For example, the level of security can be assigned as administrator, power user, user, backup operators. User names are not case sensitive but passwords are case sensitive.

**NOTE**

For the test set software to operate, the user account executing the software must be assigned Administrator or Power User privileges. Otherwise, the test set software will not operate correctly.

---

It is Agilent's expectation that each user's My Documents folder is mapped to the D: drive. This is to avoid overwriting the user's data in the event the Agilent Recovery must be performed. Also, this facilitates convenient backup by copying the contents of the D: drive to external media. All users accounts created by the factory already have My Documents mapped to the D: drive. Please map all new users My Documents folders to the D: drive.

## Agilent Licensing Options

Agilent test sets use three licensing types: Fixed Perpetual, Transportable Perpetual, and Trial. Fixed Perpetual licenses are also required to enable hardware options.

### Fixed Perpetual

Fixed Perpetual licenses are the traditional license type (Fixed) with the same duration (Perpetual) that have been available for all features since the Agilent X-Series introductions. Fixed Perpetual licenses are identified by the “F” in the second character and “P” in the third character of the option designator:

Example: V9077A-1FP

A license key is instrument model and serial number dependent. You can only install the license key on the specific instrument for which it was created.

### Transportable Perpetual

Transportable Perpetual licenses are an optional license type offering deployment duration which is not fixed to a specific instrument model and serial number. Transportable Perpetual licenses are identified in the product structure by a “T” in the second character and “P” in the third character of the option designator:

Example: V9077A-1TP

Transportable Perpetual licenses require a connection to the Agilent server only for managing the check-in/out of the license. The Agilent licensing server also provides for storage of unused licenses which have been transported off instruments but are awaiting assignment to new instruments. The server will limit the number of transports per 30 day period per application license to 10.

Unlike Fixed Perpetual licenses which are pre-installed at the factory with new instrument purchases, Transportable Perpetual licenses require redemption and installation of the license before the first use. This allows the user to determine on which instrument to initially install the application license.

Agilent recommends that instruments be at the same instrument software release to ensure the latest code is available on each instrument so that the user experience is identical between instruments. This is particularly important when transporting the license for a newly-released application which may only be available in the latest software release.

## Time-Limited Licenses

### Trial licenses

Trial licenses are available so that you may try applications before you buy the full applications. These licenses are time limited for a 14 day period, and are restricted to one trial for an individual application per instrument. The restriction is enforced through the license redemption process of the Agilent Software Manager (ASM) system.

Trial licenses are only available for measurement applications and not available for enabling hardware capability.

Trial licenses are not installed in the factory and no entitlement certificates are created for distribution with new instrument shipments. Trial licenses are not available for order, but are available from the Agilent Web site after completing a brief registration:

[http://www.agilent.com/find/e6630a\\_trial](http://www.agilent.com/find/e6630a_trial)

Trial Licenses are identified by the license designator “-TRL”.

Example: V9077A-TRL

If a product has multiple tiers (levels of functionality), the -TRL license enables all tiers for the duration of the license. If you have a base tier and want a trial license for a higher tier, you can install the -TRL license. When the duration expires the entitlement is reverted back to the base tier.

## Licensing New Measurement Application Software - After Initial Purchase

Additional measurement application software can be ordered after your initial purchase of the E6630A test set. Software upgrades are provided in a kit that includes an option based Entitlement Certificate, a license agreement. The licenses are downloaded from the license Web site onto a storage device so they can be loaded into the instrument.

If you do not want to wait for your upgrade kit to arrive, licenses can be installed using any available USB storage device. If you choose to do this, we recommend that the latest version of the instrument software be installed. This ensures that the measurement application being licensed and activated is installed and is the most current version.

The latest revision of the software may be downloaded from:

<http://www.agilent.com/find/e6630a>

A license key is usually for one instrument model and serial number combination. The license key will only install itself on that instrument.

**NOTE**

No calibration is required after a test set application installation.

### Installation procedure over USB

Step	Action	Notes
1 Redeem the Option Upgrade Entitlement Certificate	<ul style="list-style-type: none"><li>Follow the instructions on the Certificate</li></ul>	After redeeming your Option Upgrade Entitlement Certificate you will receive an e-mail with an attached License File.
2 Save the license file	<ul style="list-style-type: none"><li>Save the .lic file to the root directory of a USB storage device</li></ul>	
3 Load the license file	<ul style="list-style-type: none"><li>Connect the USB storage device to one of the test set USB ports.</li></ul>	Windows will detect the new hardware and may display the configuration menu. The test set automatically loads the license file. (This may take a few minutes) Upon completion, the Agilent License Manager displays a “Successful License Installation” message.

**NOTE**

Alternatively the license file can be manually installed over USB or LAN by placing the license file in the following folder on the test set.

C:\Program Files\Agilent\licensing



---

Step	Action	Notes
4 Verify installation	<p data-bbox="493 327 967 359"><b>a</b> Cycle the power on the signal test set.</p> <p data-bbox="493 363 967 426"><b>b</b> On the Virtual Front Panel press <b>System</b>, <b>Show</b>, <b>System</b>.</p> <p data-bbox="493 430 967 489"><b>c</b> Verify that the new application appears in the list.</p>	<p data-bbox="992 327 1430 390">The application will not be available for use until after the power has been cycled</p> <p data-bbox="992 415 1430 478">This displays the list of installed applications.</p> <p data-bbox="992 483 1430 546">If you require further assistance, please contact the Agilent support team.</p> <p data-bbox="992 550 1430 613">Online assistance: <a href="http://www.agilent.com/find/assist">http://www.agilent.com/find/assist</a></p> <p data-bbox="992 617 1430 741">If you do not have access to the Internet, contact your local Agilent Technologies Sales and Service Office, or if in the United States, call 1-800-829-4444.</p>

---

## Transporting a License Between Test Sets

Transportable licenses can be identified by the letters "TP" in their option designator. For example, V9077A-2TP indicates the license is transportable and perpetual. To transport this license from one test set to another, Agilent recommends that both test sets be at the same instrument software release. This ensures that the user experience is identical between instruments.

As a minimum, the instrument software release in the test set that will receive the transportable license (the "target instrument") must at least be able to support the desired application.

The E6630A test sets support several ways of transporting licenses. The procedure below will focus on the most common procedure, where neither of the test sets has access to an internet connection. For this procedure to work, a PC with an internet connection is required

You will need the following:

- USB flash drive
- USB keyboard
- USB mouse

We will refer to the test set from which the transportable license will be removed as the "source instrument". We will refer to the test set which will receive the transportable license as the "target instrument".

### Procedure for Transporting a License, Neither Test Set Connected to the Internet

Step	Action	Notes
1 Connect the USB devices to the source instrument	<ul style="list-style-type: none"><li>• Connect the USB flash drive, USB keyboard, and USB mouse to the USB ports on the source instrument.</li></ul>	It will be necessary to use one or more of the rear panel ports to connect the USB devices.
2 Verify software version in each test set	<ul style="list-style-type: none"><li>• On the Virtual Front Panel for each test set, press <b>System, Show, System</b> and make note of the Instrument S/W Revision on each.</li></ul>	Ideally, the revisions will be the same. But at least, both versions should be able to support the application whose license is being transported.
3 Obtain the Host ID from the Target Instrument	<ul style="list-style-type: none"><li>• On the target instrument, press <b>System, Show, System</b>, and make note of the Host ID.</li></ul>	This information will be needed to issue the license for the target instrument. The Host ID is the model number, followed by a comma, followed by the serial number.

Step	Action	Notes
4 Start the License Manager on the Source Instrument	<ul style="list-style-type: none"> <li>• On the source instrument, press <b>System, More, Licensing...</b> It may take a minute for the Agilent License Manager screen to be fully populated with all the installed licenses.</li> </ul>	
5 Transport the Transportable License from Source Instrument	<ul style="list-style-type: none"> <li>a On the source instrument, locate the desired license to be transported and highlight it. Its option designator should include the letters "TP".</li> <li>b .Right-click on the mouse and select <b>Delete</b>.</li> <li>c Click <b>Yes</b> in the License Deletion Confirmation dialog box.</li> <li>d After a few seconds, a Transport License dialog box will appear. Click <b>OK</b> and save the *.url files on the USB flash drive, with a name such as "PhaseNoise_License.url"</li> </ul>	<p>Be sure you are selecting a transportable license and not a fixed perpetual license.</p> <p>Although you are "deleting" the transportable license, the ultimate action will be to transport it.</p> <p>The information in this dialog box will be used to issue a new license for the target instrument.</p>
6 Get New License from ASM Transportation Web page	<ul style="list-style-type: none"> <li>a Insert USB flash drive into PC that is connected to the internet</li> <li>b On the PC, locate the *.url file on the USB flash drive that was saved in the previous step and click on it.</li> <li>c After a few seconds, the ASM Transportation Web page will appear. One field, the New Host ID will be empty.</li> <li>d Enter the Host ID of the target instrument (step 3 above) into the field marked New Host ID.</li> <li>e Click <b>Submit</b>.</li> </ul>	<p>The PC must have an internet connection and an available USB port.</p> <p>Most of the fields have been populated from the information in the *.url file.</p> <p>Be very careful when entering the New Host ID. A mistake made in entering the New Host ID will result in an invalid license being issued. Be sure there is a comma between the model number and serial number. There should be no spaces in the Host ID.</p>
7 Save License File to USB Flash Drive	<ul style="list-style-type: none"> <li>a The ASM Transportation Web page will indicate that a license file is available and display two links to the license file. Right-click on the license file and select <b>Save Target As...</b></li> <li>b Save the license file to the root level of the USB flash drive, keeping the ".lic" file extension.</li> <li>c Close the Save dialog and exit the ASM Transportation Web page.</li> </ul>	<p>Either link can be used to either display or save the license file.</p> <p>The license file must be saved to the root level of the USB flash drive for it to be recognized by the target instrument.</p>

### 3 Test Set Operating System

---

Step	Action	Notes
8 Install License File in Target Instrument	<p data-bbox="493 327 967 485"><b>a</b> With the target instrument running, insert the USB flash drive into one of the front panel USB ports. After a few minutes, you should see a message saying "Successful License Installation"</p> <p data-bbox="493 583 967 615"><b>b</b> Cycle power on the target instrument.</p> <p data-bbox="493 716 967 816"><b>c</b> Once the test set has re-booted, the application should be ready to use on the target instrument.</p>	<p data-bbox="992 327 1448 569">The Agilent License Services running on the target instrument looks for *.lic files whenever it detects a USB device has been inserted. If the contents of the *.lic file are appropriate for the instrument, the license will be installed automatically.</p> <p data-bbox="992 590 1448 690">Newly-installed licenses are only recognized by the instrument software on power-up.</p>

---

## Windows Configuration

The Windows settings have been optimized for the best measurement performance. Any modifications to these settings may degrade test set performance and measurement speed. In general, most Windows System settings (typically set through the Windows Control Panel) should not be modified. Those that can be safely modified are listed below.

**CAUTION**





To recover from problems caused by changing Windows systems settings, you may have to reinstall the Windows system and test set application using the Agilent Recovery process.



### Settings that can be changed

You may change the following Windows settings or administrative tasks (available from the Windows Control Panel) to select your personal preferences.

**NOTE**





Before changing any Windows System settings, exit the test set application.

You may use this feature	To do this...
 Automatic Updates	Configure Microsoft Automatic Updates.
 Security Center	Install and configure an Anti Virus program.
 User Accounts	Setup new test set user accounts.
 Network Connections	Add the test set to a network.

You may use this feature	To do this...
 Printers and Faxes	Install and configure a printer.
 Date and Time	Set the time and date.
 System	Modify System Properties, Advanced Tab settings of Performance, <i>Adjust for Best Performance</i> . Leave all other settings unchanged.

### Settings that must not be changed

Avoid changing any settings in this section. Changes to the following settings may degrade test set performance, screen displays, and measurement speed.

Do NOT use this feature	To do this...
 Power Options	Do not change Power Options. (Power Scheme, Power Button, Hibernate)
 System	Do not modify System Properties, Hardware Tab settings (Device Manager, Drivers). Do not modify System Properties, Advanced Tab settings (Performance (except <i>Adjust for Best Performance</i> ), User Profiles, Startup and Recovery, Environment Variables, Error Reporting)
 Fonts	Do not remove installed Fonts.
 Display	Do not change the following Display Settings: <ul style="list-style-type: none"><li>• Screen Saver settings</li><li>• The screen resolution, 1024 x 768</li><li>• DPI setting from Normal size (96 DPI)</li></ul>

---

**Do NOT use this feature**    **To do this...**

---

User Accounts

---

Do not delete or modify the “AgilentOnly” user account.

In addition, **DO NOT**:

- Add, delete, or modify hard-disk drive partitions.
- Delete or modify Agilent registry entries.
- Change the contents of any directories containing the name “Agilent”
- Stop these services:
  - The MSSQL\$CDF service or uninstall the “Microsoft SQL Server Desktop Engine”
  - The IIS server or tamper with any virtual directories (or their contents) that came configured with the test set.
- Uninstall these libraries, interfaces, or programs:
  - The Agilent I/O Libraries
  - The .NET Framework or any Hotfixes or Service Packs for the .NET Framework
  - The “Microsoft Visual J# .NET Redistributable Package 1.1”
  - Programs that begin with “Agilent”
  - The Adobe Acrobat Reader
- Modify
  - The Agilent I/O Library “GPIB27”, “GPIB28” interfaces shown as configured Instrument I/O in the Agilent Connection Expert or I/O Config.

## Configuring Printers

Printers are configured using the Microsoft Windows Control Panel. It is easily accessed from the Windows Start menu or from under the front panel **System** key. This setup process is most easily done using a USB mouse and an external keyboard.

When setting up a new printer, you may need to load the printer driver (unless you are using a network printer that your IT department has set up to include the driver). The manufacturer of the printer supplies the driver software and process. That may require that you attach an external USB disk drive. An alternative is to connect the test set to the LAN and download the driver from the printer manufacturer's internet site.



## Configuring LAN

### Hostname

The Computer Name, or hostname, is pre-configured from the factory. It must be a unique name so that it does not conflict with other equipment on your LAN. The pre-configured Computer Name is A-E6630A-xxxxx, where xxxxx represents the last 5 digits of the test set serial number.

To change the Computer Name consult the Microsoft Windows Help and Support Center.

### IP Address & Gateway

The test set is pre-configured to obtain an IP Address using DHCP. The IP Address and Gateway can be changed. Consult the Microsoft Windows Help and Support Center to configure the LAN.

## Windows Security

Microsoft recommends the following to ensure the test set Windows operating system is protected:

- Use an internet firewall.
- Get the latest critical Windows updates.
- Use up-to-date antivirus software.

To check the status or make changes in the security settings for your test set, open the Windows Security Center, click **Start, Control Panel**, and then click **Security Center**.



#### NOTE

The window may look slightly different on your test set.

## Windows Firewall

The test set is shipped with the Windows Firewall enabled.

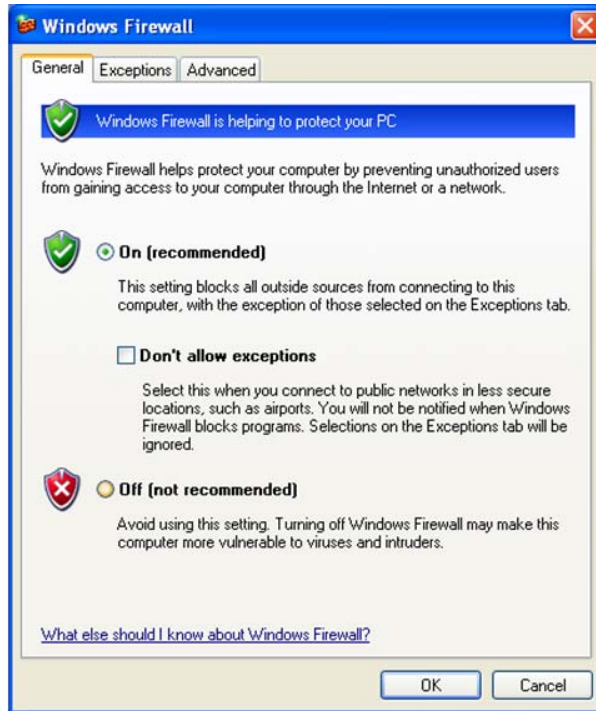

### NOTE

The window may look slightly different on your test set.

Windows Firewall **Exceptions** for programs and ports have been added to allow proper operation of the test set over a network. Modifying these settings may cause the test set to not operate properly.

## Automatic updates

The default test set setting is to automatically check for critical Windows Updates and notify you, if the test set has internet access.

You can change the configuration of the Microsoft Automatic Updates. You can choose not to have automatic updates. Then you can manually update Windows by accessing Internet Explorer and from the Tools menu select Windows Update.



**NOTE**

Be aware that downloading and installing Windows Updates can be network and CPU usage intensive (impacting the test set performance), and some Windows Updates automatically reboot the test set. It is recommended that Windows Updates be performed when the test set is not in normal use.

## Virus protection

There is no antivirus software included with your test set. Antivirus application software has been tested to be compatible with the test set. See the section on “3rd party software verified by Agilent” on page 43 for anti-virus software that has been tested by Agilent.

**NOTE**

Having antivirus software installed may have a slight impact on the test set performance.



## Spyware protection

There is no anti-spyware software installed on the test set. This should not be a problem if you do not use the test set for a lot of internet browsing. Having spyware in the test set could have an impact on the test set performance.

## System Maintenance

### Backup

It is recommended that you have a regular backup strategy. Your IT department may already have a backup strategy in place which is suitable for the test set and its data. Using the Agilent Recovery system in conjunction with a regular backup strategy should allow full recovery of the test set data.

The Windows operating system has a Backup utility that you can use to archive files and folders in case of a hard disk drive failure. See the Microsoft Windows Help and Support Center for more information on this utility. You can also use third party backup utilities. However, you must ensure that this third party software is compatible with the test set's system software. See "Customer Installation of Software" on page 43 for more information.

When performing backups, we recommend that you backup the data to an external storage device connected to the network or one of the test set's USB connectors. Also, you should perform backups at times when the test set is not being used for normal operations as it may impact the test set's overall performance.

### System restore

Windows contains the capability to restore the system to a previous point in time. System Restore is enabled with default settings as provided by Microsoft. However, System Restore is not 100% successful. Therefore, it is not the recommended method to backup the test set. System Restore has not been tested to verify successful restoring.

### Disk defragmenting

Over time the hard disk on the test set becomes fragmented. Windows has a Disk Defragmenter utility that you can use to defragment the hard disk. See the Microsoft Windows Help and Support Center for more information on this utility.

**NOTE**

Running Disk Defragmenter should be performed when the measurement application is not running. Measurement throughput is significantly impacted while disk defragmentation is in process.

---

## USB Connections

All of the USB ports are compatible with the USB 2.0 and 1.1 specification. The four USB ports on the front panel of the M9036A Controller (see graphic below) are USB Series “A” ports. These are ports to which you can connect USB mass storage devices, accessories such as printers and keyboards, and the E6618A Multiport Adapter. The test set USB Host support includes the standard Microsoft Windows USB class drivers for human interface, mass storage, printing, scanning, and imaging devices. A complete up-to-date list of the Windows USB class driver support is available on the Microsoft website.

[http://www.microsoft.com/whdc/system/bus/usb/USBFAQ\\_intro.mspx](http://www.microsoft.com/whdc/system/bus/usb/USBFAQ_intro.mspx)

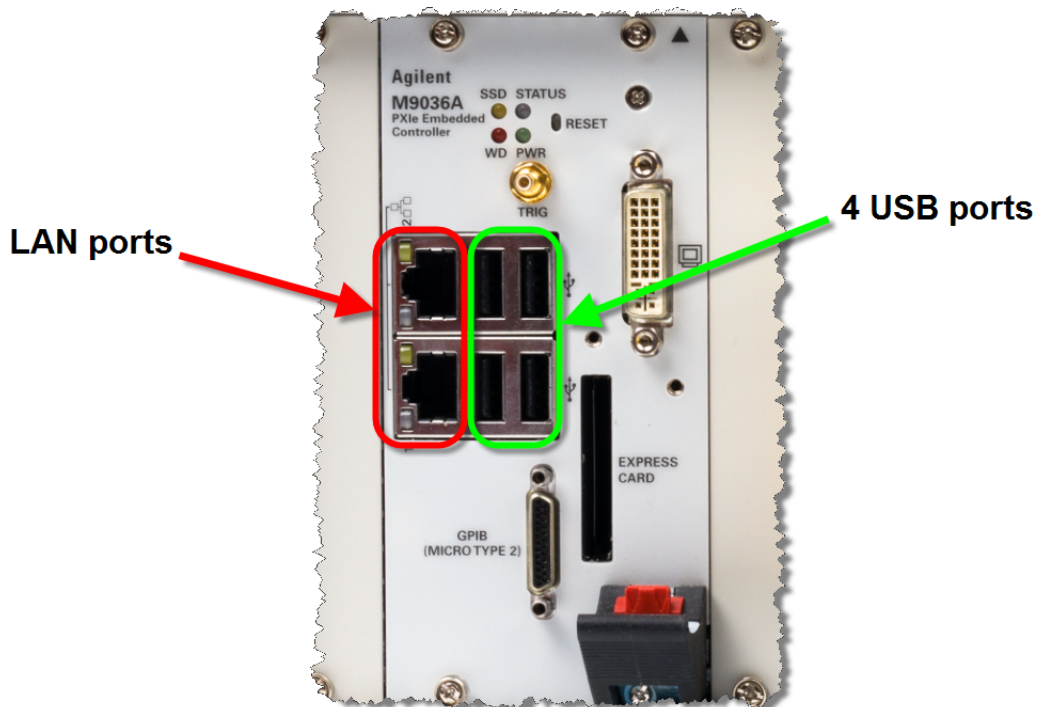

The test set USB device driver included in the test set software supports the test and measurement industry standard USBTMC-USB488 device class.

In addition, the Agilent IO Libraries CD that was included with your test set contains USB Host drivers that allow control of other test sets connected to the USB bus.

Agilent Technologies does not support or warrant correct test set operation if additional USB drivers from third parties are installed in the test set. It is possible that additional drivers could break the normal USB operation. If USB operation is broken, recovery would require reinstalling the test set application using the hard drive recovery process.

## Hard Drive Partitioning and Use

The drive is partitioned into 3 sections: C:, D: and E:

- The **C: partition** contains the Windows operating system and software installed by Agilent. This is an Open System which means you can install additional software, and these should be installed on the C: drive. However, only a limited set of software applications are tested for use with the Agilent measurement software. The installation and/or use of other software is not warranted, and could interfere with the operation of the measurement software. If test set repair is ever needed, the Agilent version of the C: drive is the only part of the test set software that is restored by the Agilent Recovery process. You must reload any other software that you have added in the test set.
- The **D: partition** is reserved for data storage. The User Accounts that are configured by Agilent have their My Documents folder mapped to the D: drive. This is for the convenience of backing-up the measurement data. You should always back-up the data on the D: drive to an external device. This allows you to restore the data if you ever need to replace the hard drive.
- The **E: partition** is reserved for Agilent's use. The primary use of the E: drive is for housing the Calibration and Alignment data. Do not change or overwrite the files on this drive. This could cause your test set to not meet specifications, or even to stop functioning correctly. Do not use this drive for data storage. It is also recommended that you back up the contents of this drive by using the factory calibration data backup utility.



## Hard Drive Recovery Process

The Agilent Recovery System can be used to repair errors on the test set's C: drive partition, or to restore the original factory configuration of the system software. The Agilent Recovery System is stored in a separate hidden hard disk drive partition.

Repairing errors on the hard disk drive may result in loss of data or files. If you need more information about the Windows “chkdsk” error repair process, see the chkdsk documentation in the Microsoft Windows Help and Support Center.

Restoring the original factory system software does not restore any of the following items:

- Windows system configurations that were made after the test set was shipped from the factory. For example, Windows and Service Pack updates, user accounts, and Windows configuration settings. After an Agilent Recovery, these configurations need to be redone.
- Additional software that was installed after the test set was shipped from the factory. After an Agilent Recovery, that software needs to be re-installed.
- Any data or programs saved on the D: or E: drives.
- Any upgrades that were made to the Agilent measurement application software.

Restoring the original factory system software will not synchronize the code in the Field Programmable Gate Arrays (FPGAs) on the various hardware assemblies. As a result, you may see an error dialog box appear during the final boot-up at the end of the recovery process. This typically occurs when there are significant differences between the software version installed prior to performing the recovery and the version restored by the recovery. In these situations, upgrade the software to the latest version.

**NOTE**

It is recommended that you use a regular back up strategy. Your IT department may already have a back up strategy in place which is suitable for the test set and its data. See “[System Maintenance](#)” on page 62. Using the Agilent Recovery System in conjunction with a regular back up strategy should allow you to fully recover the test set software and data.

It is recommended that routine backups of the test set information be performed to keep current archives of the test set information. This allows a full recovery of the test set information after the test set recovery system operations are performed. See “[Backup](#)” on page 62 for more details.

**Using the test set recovery system**

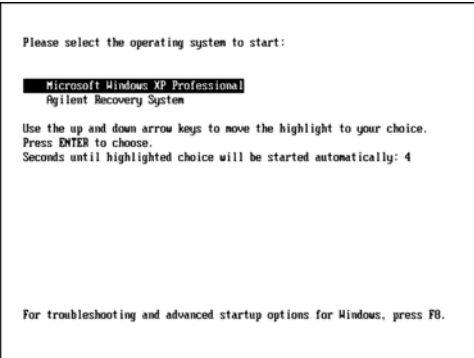
Step	Notes
1 Make sure the test set is turned off.	
<p>2 Turn on the test set.</p> <ul style="list-style-type: none"> <li>Press the down arrow key to move the highlight to <b>Agilent Recovery System</b>, then press <b>Enter</b>.</li> </ul>	<p>After the Agilent Technologies screen is displayed,</p>  <p>this screen is displayed for five seconds.</p> 
<p>3 When the Agilent Recovery System has booted, follow the on-screen instructions to recover the image of the C: drive.</p> <ul style="list-style-type: none"> <li>Press <b>2</b>, then press <b>Enter</b> to select the recovery.</li> <li>Press <b>1</b>, then press <b>Enter</b> to continue.</li> <li>Press <b>1</b>, then <b>Enter</b> to confirm.</li> </ul>	<p>It may take up to 25 minutes for this process to complete</p>

After exiting the Agilent Recovery System, the test set reboots. If the original factory test set system has been restored, the test set re-executes the following process: "Turning on the test set the first time" on page 15

**NOTE**

Additional recovery steps may be required to fully recover the system to a more current working state. This could involve restoring your own backups of the test set configuration, including re-installing applications, data, and performing system customizations.

## Updating the software

The purpose of this update is to ensure that the E6630A's software, its measurement mode applications, and the FPGA content of its PC boards are all current and up to date.

NOTE An update to the instrument software revision does not require a new license key for the measurement applications, so long as the applications were licensed prior to the update.

NOTE This procedure will only update the instrument software that currently resides on the C: drive of the instrument. It will not update the version that exists on the recovery partition. Because of this, if the recovery process is performed, the instrument will revert back to the instrument software revision that was originally shipped from the factory.

### Determining the current software revision

To determine what revision of instrument software is currently installed, press **System, Show, System** using the instrument's virtual front panel. You can access the virtual front panel using a mouse and right-clicking in the application window, and selecting **Utility, Virtual Front Panel**. Once in the show system screen, look for the "Instrument S/W Revision" entry (for example: "A.13.85"). If the installed revision is the same as the latest revision on the web, there is no need to update the instrument software.

### Requirements

The following requirements must be met to use this procedure:

- The E6630A must be functioning properly before the update is attempted.
- You must have a USB keyboard and mouse.
- You must be able to log in to the instrument as the administrator.
- You must be able to transfer a large file (~1 GByte) to the E6630A being updated.

### File Download

1. Go to <http://www.agilent.com/find/e6630a> and go to the Technical Support section; select the Driver, Firmware & Software tab.
2. Download the executable file by clicking on the file link. Save the file to a location of your choice. If you do not have the ability to download files directly to the C: drive of the E6630A being updated, store the file on a large capacity USB storage device for transfer to the instrument. (The file size is ~1 GByte.)

#### User account and log-in

The default user account is **Instrument**, which does not have the required permissions to install the instrument software updates. For the process outlined below, the user must be logged in as **Administrator**.

The automated instrument software upgrade process has an install wizard which removes the old software version and installs new software version without manual steps. The removal of the old software version and the installation of the new software version completes in approximately 15 minutes.

1. Connect a USB keyboard and mouse to the E6630A.
2. If the E6630A is not already running, power it up and allow it to boot up completely.
3. If one or two E6618A Multiport Adapters will be used with the E6630A, connect the E6618As to the E6630A via USB cables and power them on. (The software upgrade process may need to involve updating of FPGAs in the E6618A units, to make them compatible with the new E6630A software.)
4. Close the E6630A measurement application if it is running. Right-click in the application window, and select **Utility > File** from the right-click menu; select the **Exit** softkey and click **OK** in the confirmation window.
5. Log out as the default user (Instrument). Click the Start icon at the lower left corner of the screen, and select **Log Off**.
6. Select the Administrator icon on the Windows desktop, to log in as follows:  
User Name: administrator  
Password: agilent4u
7. If a “Found New Hardware” wizard window pops up, select “No, not at this time” to bypass the activity.

#### Instrument software installation

If you downloaded the instrument software update file to the instrument via LAN, access that file from the location that it was stored and proceed to step 1.

If you downloaded the instrument software update file to a USB storage device, plug that into one of the USB ports on the front of the instrument. Access the file for the removable drive, then proceed to step 1.

#### Preparing the installation

Step	Notes
1 Double click on the installer file, and click <b>Yes</b> in the confirmation window that appears.	The file name is in the format: XSA_Installer_A.XX.XX.exe

## Preparing the installation

Step	Notes
2 A window appears showing the extraction of the software installer. Click Install in the confirmation window to begin the installation process. When the extraction process is complete, a software updater display appears, showing progress of the software removal and installation.	The update process causes various messages and windows to appear and disappear on the screen, but the process doesn't require further interaction. Examples of what will be displayed are shown below, as a guide to what the process looks like while it is running.

Extraction window:

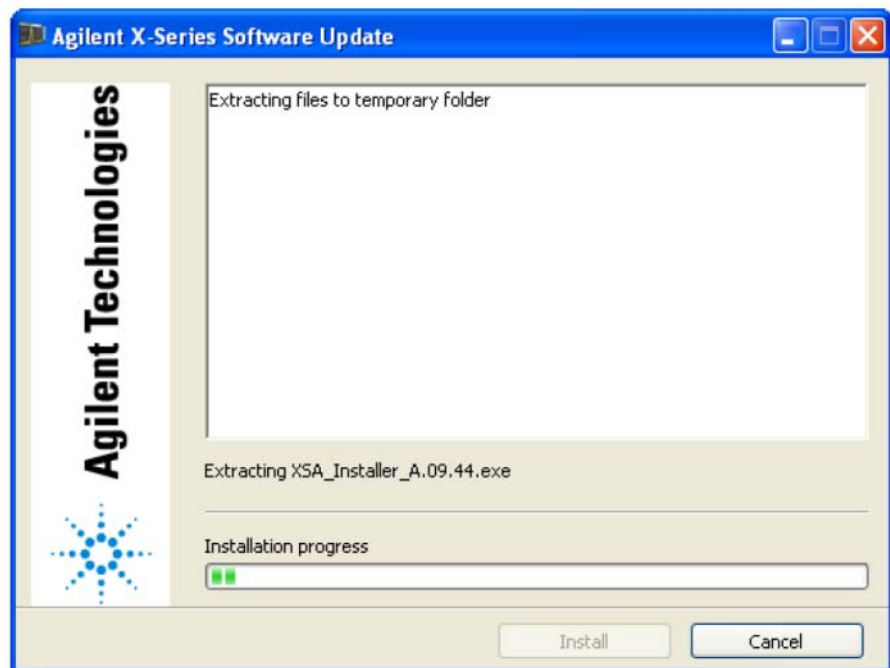

#### Preparing the installation

Step	Notes
------	-------

Software updater window, showing uninstallation progress:

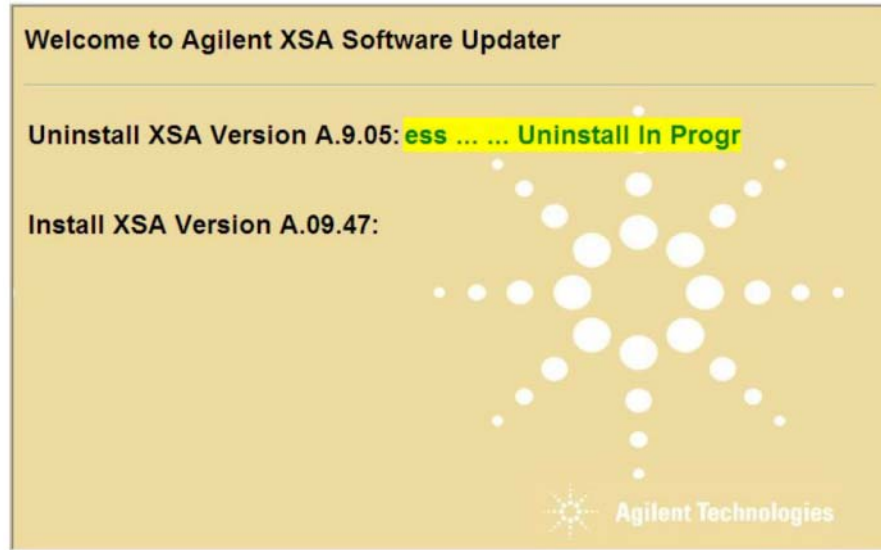

While the old instrument software is being uninstalled, the text “Uninstall in Progress” text rolls across the screen, to be replaced finally by “Completed Successfully”. No interaction is required at this point.

Software updater window, showing installation progress:

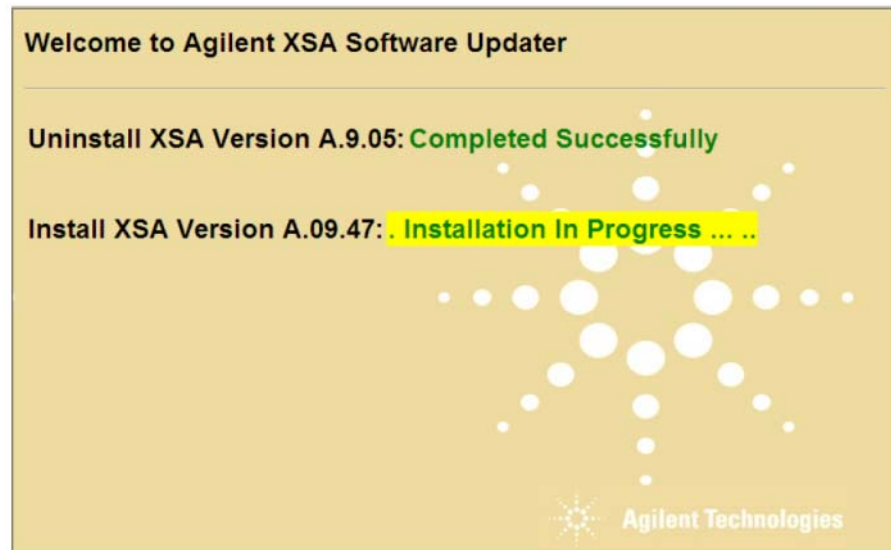

While the new instrument software is being installed, the text “Installation in Progress” text rolls across the screen, to be replaced finally by “Completed Successfully”. No interaction is required at this point. Please be patient: the total installation process can take 30 to 40 minutes.

**Preparing the installation**

Step	Notes
	FPGA update warning window (may be displayed, if any FPGA updating occurs):

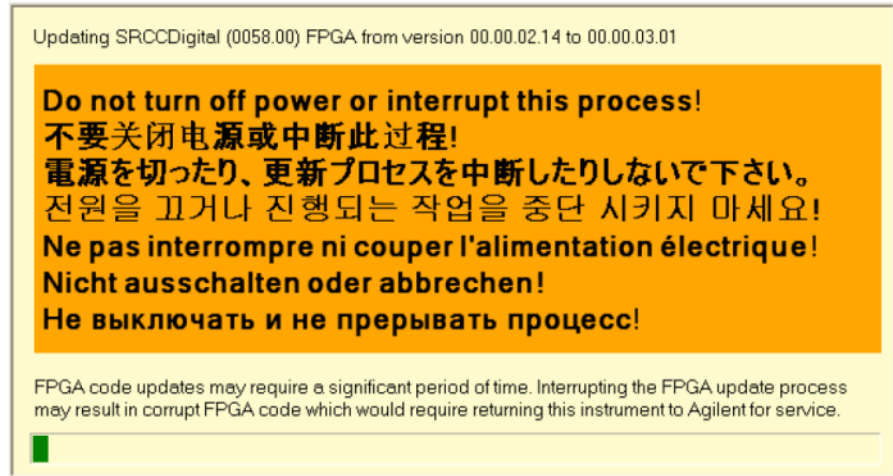

**CAUTION** During FPGA programming, **DO NOT** power off the E6630A for **ANY** reason! Interrupting the FPGA update process can place the instrument in an unusable state, requiring it to be returned to Agilent for repair.

- |   |   |   |
|---|---|---|
| 3 | When the software updater window shows “The software upgrade was successful”, you will be prompted to reboot. | Reboot the E6630A by clicking <b>Finish</b> in the window. Windows will display a “System Shutdown” warning window; this is normal. |
|---|---|---|

Software updater window, showing completion of the process:



**Preparing the installation**

Step	Notes
4	After the E6630A restarts, it will boot up in the default “Instrument” account, perform alignments, and finally display the measurement screen.
5	Check for any errors, and verify that the new software version is installed.

If the instrument does not reboot, remove the USB storage device and cycle power. The boot order for the instrument may have been changed in the instrument BIOS previously, and the instrument may be instructed to boot from USB first, and the internal drive second. If this is the case, failure to remove the USB device will result in an error, as the instrument attempts to boot from it.

In the right-click menu, Press **System**. In the System menu, press **Show, System**. Look for the line “Instrument S/W Revision”.

Instrument S/W Revision:

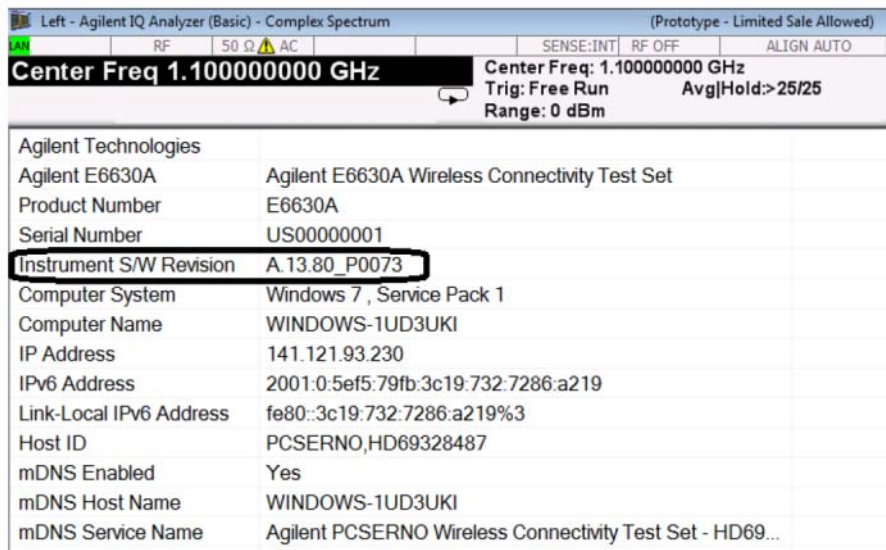

It is possible a newer version of the instrument software is available on the web at <http://www.agilent.com/find/e6630a>

**NOTE** Additional recovery steps may be required to fully recover the system to a more current working state. This could involve restoring your own backups of the instrument configuration, including re-installing applications, data, and performing system customizations.



## Configuring recovery prompt timing

You can configure the time at which the test set power-up process waits for the selection of the recovery process by performing the following steps:

Step	Notes
1 Right-click <b>My Computer</b> , and click <b>Properties</b> .	This accesses the System Properties tabbed page.
2 Click the <b>Advanced</b> tab.	
3 In the <b>Startup and Recovery</b> section, click <b>Settings</b> .	
4 Under the <b>System Startup</b> section: <ul style="list-style-type: none"> <li>• you can either clear the <b>Time to display a list of operating systems</b> check box, or,</li> <li>• select the <b>Time to display recovery option when needed</b> check box and change the seconds to delay for it</li> </ul>	

**NOTE**

You must be logged in as an administrator to change these settings. See "User Accounts" on page 44 for more information.

### **3 Test Set Operating System**



## 4 Using Microsoft Windows Operating System

**NOTE**

The capabilities described in this section are Microsoft Windows features. The following information provides some guidelines for using the capabilities with the test set. You need to refer to the Windows help documentation for more information. Your version of Windows may not match these instructions exactly.

You need an external keyboard and mouse to fully use these features.

---

“Navigating Windows Without a Mouse” on page 76

“Remote Desktop: Using the Sest Set Remotely” on page 77

“Capturing/Printing Displays and Windows” on page 91

“Windows Shortcuts and Miscellaneous Tasks” on page 92



## Navigating Windows Without a Mouse

Key Presses	Actions
<b>Esc</b>	Exits/closes a Windows dialog box (does not exit an Application window)
<b>Enter</b>	Does the current "default action". If a menu item or a button is currently highlighted, then the Enter key activates that menu item or button.
<b>Alt</b>	Moves focus/control to the pull down menus bar in the active Window
<b>Right Arrow</b>	In pull-down menu: opens the next menu to the right, or opens a submenu  In a dialog box: selects an option button
<b>Left Arrow</b>	In pull-down menu: opens the next menu to the left, or opens a submenu  In dialog box: selects an option button
<b>Up Arrow</b>	In pull-down menu: Moves to next selection up in the menu  In dialog box: selects an option button
<b>Down Arrow</b>	In pull-down menu: Moves to next selection down in the menu  In dialog box: selects an option button
<b>Tab</b>	In dialog box: moves to the next/previous field
<b>Del</b>	Deletes the currently selected item
<b>Alt + Tab</b>	Switches between the next/previous Application
<b>Alt + Enter</b>	Shows the Properties of the currently selected item
<b>Alt + Esc</b>	Cycles through items in the order that they had been opened
<b>Backspace</b>	In My Computer or Windows Explorer: move up one level  In Internet Explorer: works like the BACK arrow key
<b>Ctrl + Left arrow</b>	Moves to the left one word at a time
<b>Ctrl + Right arrow</b>	Moves to the right one word at a time
<b>Ctrl + Tab</b>	In dialog box: moves to the next/previous Tab location
<b>Alt + Space</b>	Opens the window control menu for the currently active window, allowing you to minimize, maximize, move and restore (size) the window
<b>Ctrl + Esc</b>	Opens the Windows Start Menu
<b>Ctrl + Alt + Delete</b>	Opens the Windows Task Manager

## Remote Desktop: Using the Sest Set Remotely

Windows Remote Desktop is recommended for remote control of the test set.

### NOTE

The Remote Desktop functionality is a Microsoft Windows capability. The following discussion provides some guidelines for using this capability with the test set. You need to refer to the Windows help documentation for more information. As Windows evolves, these instructions may no longer be exact.

You need an external keyboard and mouse to fully use this functionality.

### Overview of Remote Desktop operation

Using the Remote Desktop functionality of the test set allows you to control and interact with the test set from a remote computer, as though you were sitting in front of the test set.

When you have configured the test set for remote connectivity, and configured a separate computer to act as a Remote Desktop Host, you can send commands to the test set from the remote computer, and you can see the test set display on the screen of the remote computer.

This section provides full details of how to set up the test set for remote connectivity, and also how to set up a computer running any 32-bit version of Microsoft Windows as a Remote Desktop Host.

### Setting up Remote Desktop operation

#### Setting up the test set

Before the test set can be controlled through a Remote Desktop Connection, it must be set up to allow connection from a remote computer.

#### Setting up a remote desktop connection

Step	Notes
1 To perform this operation successfully, you must have Administrator level access to the test set.	The default Administrator password is: <code>agilent4u</code>

### Setting up a remote desktop connection

Step	Notes
2	On the test set, open the Windows <b>Control Panel</b> . <ul style="list-style-type: none"><li>Using the Virtual Front Panel within the test set application, press <b>System, Control Panel</b>, <i>or</i>, From the Windows Desktop, click <b>Start, Control Panel</b>.</li></ul>
3	Within the Control Panel, select <b>System, System and Security</b> .
4	Click <b>Remote Settings</b> . A System Properties window appears, with the Remote tab displayed.
5	Check the box labeled <b>Allow Remote Assistance</b> connections to this computer, if it is not already checked.
6	To add users, click <b>Select Users, Add</b> . <ul style="list-style-type: none"><li>Follow the on screen instructions.</li></ul>

### Basic setup for remote desktop operation

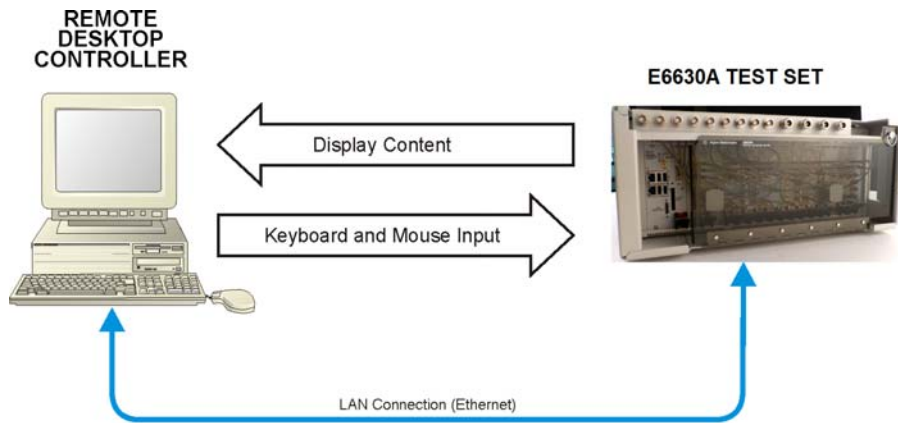

### Setting up the remote computer

The procedure depends on whether the Remote Computer to be set up is running Windows XP, Windows 7, or another version of Microsoft Windows.

**Remote computer running Windows XP or Windows 7** Windows XP and Windows 7 include the Remote Desktop Connectivity Client software, so no additional setup is required.

**Remote computer running another version of Windows** You can use any 32-bit version of Windows (Windows 95, 98, ME, NT4, or 2000) to install and run the Client software for Remote Desktop Connectivity. However, you need to have available a Windows XP or Windows 7 installation CD-ROM, because that contains the Client software.

**NOTE**

The following instructions relate to software provided by Microsoft Corporation. Agilent offers no warranty regarding the operation of such software. The procedure described here may be changed by Microsoft at some future time.

### Installing the Client software

Step	Notes
1 When the Welcome Screen appears, click <b>Perform additional tasks</b>	
2 From the <b>What do you want to do?</b> screen, click <b>Set up Remote Desktop Connection</b> .	The Remote Desktop Connection InstallShield Wizard appears.
3 Click <b>Next</b> .	Follow the on screen instructions provided by the Wizard.
4 To access the installed software, click <b>Start &gt; All Programs &gt; Accessories &gt; Communications &gt; Remote Desktop Connection</b> .	

### How to locate the computer name of the test set

To connect a remote computer to the test set, you need to know its Computer Name. The Computer Name can be displayed as follows:

#### Locating the name from the Agilent application

Step	Notes
<ul style="list-style-type: none"> <li>On the test set front panel, press <b>System, Show, System</b>.</li> </ul>	A page listing various parameters appears. The test set's computer name is shown in the list next to the title Computer Name.

#### Locating the name from the Windows desktop (with a mouse):

Step	Notes
1 Click <b>Start, Control Panel</b> .	In the Control Panel window, select <b>System and Security, System</b> .

### Locating the name from the Windows desktop (with a mouse):

Step	Notes
2 The computer name is displayed in the <b>System</b> window, under the heading “Computer name, domain, and workgroup settings”.	The Computer Name is listed as <b>Full computer name</b> .

### Locating the name from the Windows desktop (without a mouse):

Step	Notes
1 Press <b>Ctrl+Esc</b> to display the Windows <b>Start</b> menu.	
2 Use the <b>Up Arrow</b> or <b>Down Arrow</b> keys to select the <b>Control Panel</b> item.	
3 Press <b>Enter</b> to open the Control Panel dialog.	
4 Use the <b>Tab</b> key to highlight <b>System and Security</b> , then press <b>Enter</b> .	The <b>System and Security</b> window is displayed.
5 Use the <b>Tab</b> key to highlight <b>System</b> , then press <b>Enter</b> .	The <b>System</b> window is displayed.
6 The computer name is displayed in the <b>System</b> window, under the heading <b>Computer name, domain, and workgroup settings</b> .	The Computer Name is listed as <b>Full computer name</b> .
7 To close the Control Panel dialog: <ul style="list-style-type: none"><li>• Press <b>Alt</b> to open the drop-down File menu</li><li>• Press the <b>Down Arrow</b> until the <b>Close</b> menu item is selected</li><li>• Press <b>Enter</b> to close the Control Panel dialog.</li></ul>	



## Running a Remote Desktop session

### Initializing a Remote Desktop session

#### NOTE

To initialize a Remote Desktop Session, you need to know the Computer Name of the test set. This information can be shown on the test set display by following the procedure in the section “How to locate the computer name of the test set” on page 79.

After setting up both the test set and the remote computer for Remote Desktop Connectivity, as described in “Setting up Remote Desktop operation” on page 77, you are ready to start a Remote Desktop session.

### Starting a session

Step	Notes
1 Click <b>Start &gt; All Programs &gt; Accessories &gt; Communications &gt; Remote Desktop Connection</b> .	A Remote Desktop Connection dialog appears:
	
2 Enter the computer name of the test set.	
3 Click <b>Connect</b> .	A login dialog box appears.
4 Enter the login account name and password.	The default account name is <i>Instrument</i> and the default password is <i>measure4u</i> , but these parameters may be changed by instrument users.

#### NOTE

Only the current User or an Administrator can remotely log into the test set. To see who the current user of the test set is, press **Ctrl+Esc** on the test set until you can view the current user name on the Start menu. If no one is currently logged into the test set, any valid instrument user can remotely log in.

The test set display appears on the screen of the remote computer. Because the test set front-panel keys are not available when using the test set remotely, three alternative methods are available to perform the functions of the front-panel keys, as detailed in the following sections:

## 4 Using Microsoft Windows Operating System

- “Accessing menus for Remote Desktop operation” on page 85
- “Keycode commands for Remote Desktop operation” on page 86
- “The Virtual Front Panel” on page 90

### Setting Remote Desktop options

---

Step	Notes
------	-------

---

- 1 On the Remote Desktop Connection menu, click **Options**.

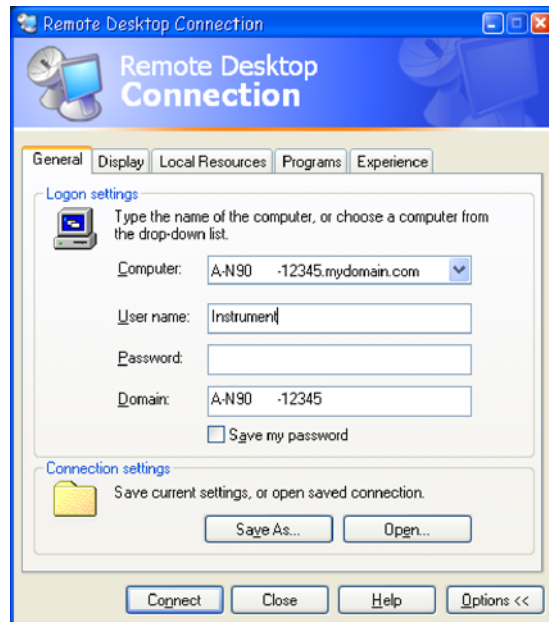

The Options dialog has several tabs. Generally, the default settings are correct.

- 2 Under the **General** tab, ensure that the Computer name, User name and Domain name are set correctly. You may choose to enter the password and save it for future sessions, by checking the **Save my password** box.
-

## Step

## Notes

3 Click the **Display** tab.

- Under **Remote desktop size**, you may select the size of the window in which the test set display appears. Do *not* select any size smaller than 1024 x 768 pixels. Selecting a remote desktop size smaller than 1024 x 768 results in the test set display not being fully visible. In such circumstances, scroll bars do not appear, so portions of the display are not accessible.
- Under **Colors**, you may select any setting that uses 15 bits or more. Selecting a color setting that uses less than 15 bits results in dithering and incorrect color rendition of the remote desktop window.

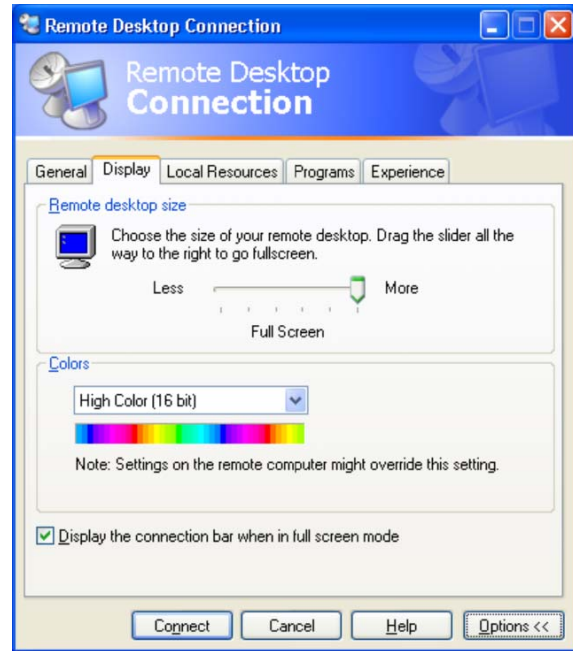
4 Click the **Local Resources** tab.

- Selecting the **Disk Drives** checkbox enables you to transfer data between the remote desktop and the local PC. To transfer data, click **Start** on the task bar of the remote computer, then click **My Computer**. Explorer opens on the remote computer and displays the drives of both the remote computer and the local computer. You can now copy and paste between the two disk drives.

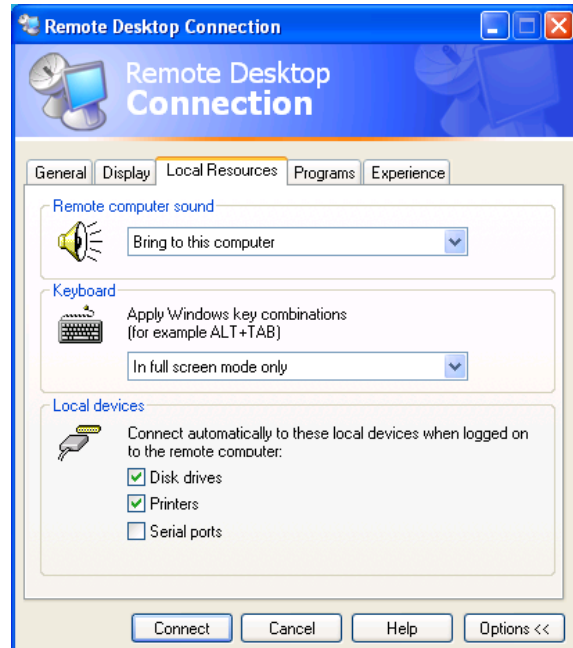

---

Step	Notes
5 Click the <b>Experience</b> tab.	To Optimize the performance of the Remote Desktop session, choose the appropriate connection format from the drop-down list.

---

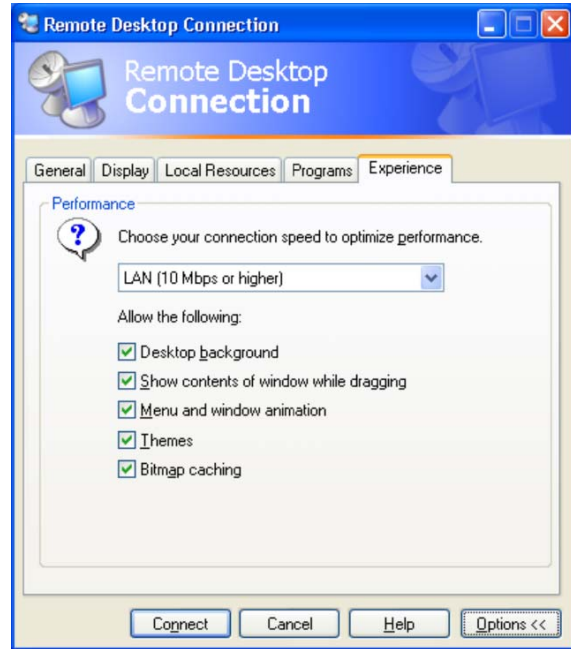

## Accessing menus for Remote Desktop operation

Using the mouse, right-click the application display window to access the following remote desktop menus:

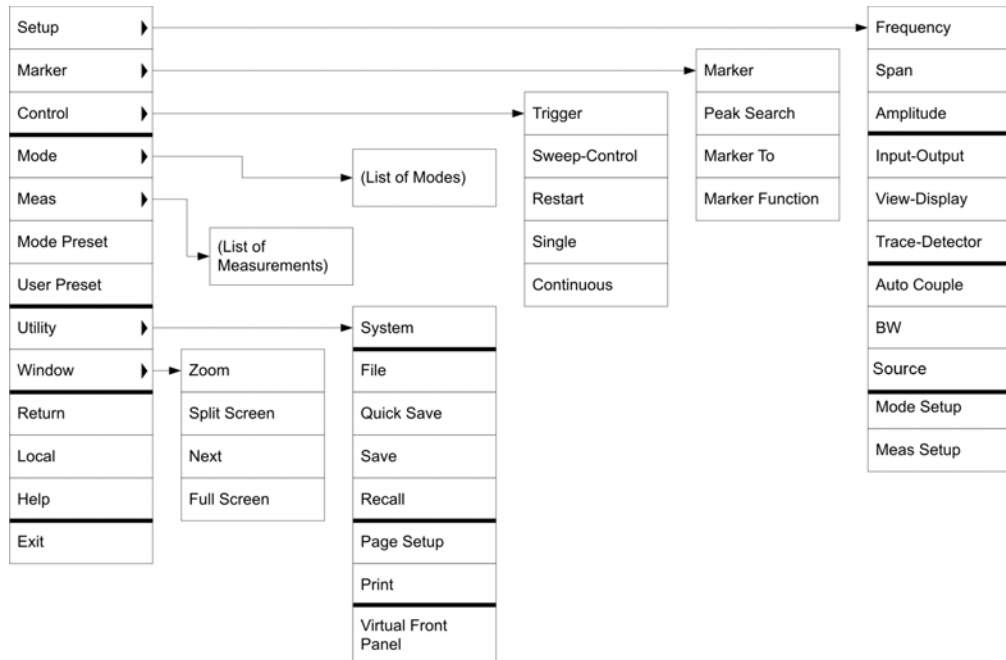

The function of each selection in the menu is generally identical to that of the corresponding Virtual Front Panel key. The following lists additional functionality:

**Exit** – Selecting this item closes the Application software.

**Utility > Page Setup** – Selecting this item opens a printer setup dialog.

**Utility > Virtual Front Panel** – Selecting this item opens the Virtual Front Panel window, as described in the Section “The Virtual Front Panel” on page 90.

### NOTE

The menus are also available when using the test set directly, provided that a mouse or other pointing device is attached to it.

### Keypcode commands for Remote Desktop operation

When using the test set in remote desktop mode, the following combinations of remote keyboard keys can be used to perform the operation of the virtual front-panel keys.

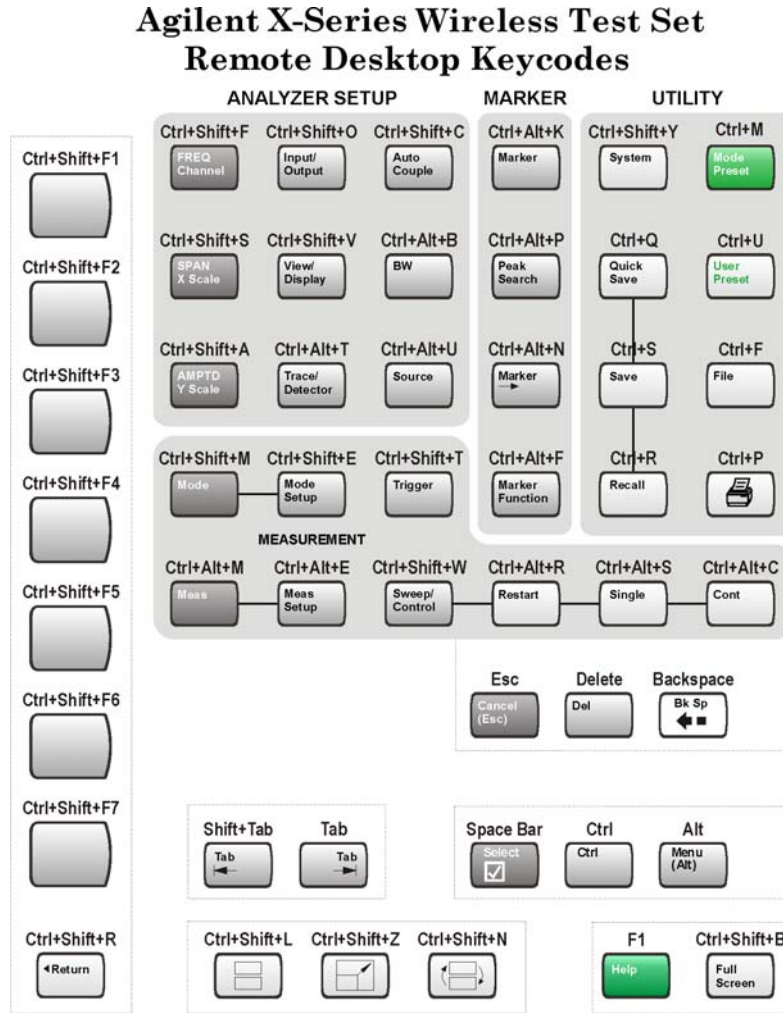

### Keypcode commands

To initiate the following virtual key:	Press these keys on the remote computer keyboard:
AMPTD Y Scale	Ctrl+Shift+A
Auto Couple	Ctrl+Shift+C
Bk Sp	Backspace
BW	Ctrl+Alt+B
Cancel (Esc)	Esc

**Keycode commands**

To initiate the following virtual key:	Press these keys on the remote computer keyboard:
Cont	<b>Ctrl+Alt+C</b>
Ctrl	<b>Ctrl</b>
Decrease Audio Volume	the Volume Control slider
Del	<b>Delete</b>
Down Arrow	Down Arrow
Enter	<b>Enter (Return)</b>
File	<b>Ctrl+F</b>
FREQ Channel	<b>Ctrl+Shift+F</b>
Full Screen	<b>Ctrl+Shift+B</b>
Help	<b>F1</b>
Increase Audio Volume	the Volume Control slider
Input/Output	<b>Ctrl+Shift+O</b>
Left Arrow	Left Arrow
Marker	<b>Ctrl+Alt+K</b>
Marker ->	<b>Ctrl+Alt+N</b>
Marker Function	<b>Ctrl+Alt+F</b>
Meas	<b>Ctrl+Alt+M</b>
Meas Setup	<b>Ctrl+Alt+E</b>
Menu (Alt)	<b>Alt</b>
Mode	<b>Ctrl+Shift+M</b>
Mode Preset	<b>Ctrl+M</b>
Mode Setup	<b>Ctrl+Shift+E</b>
Mute	the <b>Mute</b> checkbox under the Volume Control
Next Window	<b>Ctrl+Shift+N</b>
Peak Search	<b>Ctrl+Alt+P</b>
Print	<b>Ctrl+P</b>
Quick Save	<b>Ctrl+Q</b>
Recall	<b>Ctrl+R</b>
Restart	<b>Ctrl+Alt+R</b>
Return	<b>Ctrl+Shift+R</b>

**Keycode commands**

To initiate the following virtual key:	Press these keys on the remote computer keyboard:
Right Arrow	Right Arrow
Save	<b>Ctrl+S</b>
Select	Space Bar
Single	<b>Ctrl+Alt+S</b>
Softkey 1	<b>Ctrl+Shift+F1</b>
Softkey 2	<b>Ctrl+Shift+F2</b>
Softkey 3	<b>Ctrl+Shift+F3</b>
Softkey 4	<b>Ctrl+Shift+F4</b>
Softkey 5	<b>Ctrl+Shift+F5</b>
Softkey 6	<b>Ctrl+Shift+F6</b>
Softkey 7	<b>Ctrl+Shift+F7</b>
Source	<b>Ctrl+Alt+U</b>
SPAN X Scale	<b>Ctrl+Shift+S</b>
Split Screen	<b>Ctrl+Shift+L</b>
Sweep/Control	<b>Ctrl+Shift+W</b>
System	<b>Ctrl+Shift+Y</b>
Tab	<b>Tab</b>
Trace/Detector	<b>Ctrl+Alt+T</b>
Trigger	<b>Ctrl+Shift+T</b>
Up Arrow	Up Arrow
User Preset	<b>Ctrl+U</b>
View/Display	<b>Ctrl+Shift+V</b>
Zoom	<b>Ctrl+Shift+Z</b>
1	<b>1<sup>a</sup></b>
2	<b>2<sup>a</sup></b>
3	<b>3<sup>a</sup></b>
4	<b>4<sup>a</sup></b>
5	<b>5<sup>a</sup></b>
6	<b>6<sup>a</sup></b>



**Keycode commands**

To initiate the following virtual key:	Press these keys on the remote computer keyboard:
7	7 <sup>a</sup>
8	8 <sup>a</sup>
9	9 <sup>a</sup>
–	Use the – key to enter a negative value, as appropriate <sup>a</sup>
. (Decimal Point)	. (Period) <sup>a</sup>
0 (Zero)	0 (Zero) <sup>a</sup>

- a. For remote keyboards that feature a numeric keypad, use either the appropriate numeric keypad key or the main keypad key.

**NOTE**

The effect of pressing **Ctrl+Alt+Delete** on the keyboard of the remote computer *always* applies to the remote computer, and not to the test set. Generally, the effect of pressing this key combination is to display the Windows Task Manager. Therefore, pressing this key combination on the remote computer does *not* allow you to reboot the test set.

**Ending a Remote Desktop session**

There are two ways to disconnect the remote computer from the test set to end the session:

Step	Notes
1 Click the <b>X</b> , then click <b>OK</b> .	For full-screen, the X appears at the top center of the window.  For non full-screen, the X appears in a red box at the right of the window's title bar.
or	
2 When the remote desktop is full screen, move the cursor to the bottom left of the window: <ul style="list-style-type: none"> <li>Click <b>Start, Disconnect</b>.</li> <li>Click <b>Disconnect</b>.</li> </ul>	You are asked to confirm that you want to disconnect.

## The Virtual Front Panel

The Virtual Front Panel is a software equivalent of the front-panel key set, which provides another alternate method for test set control. It may be displayed in a separate window on the test set (or remote desktop) display.

**NOTE** The Virtual Front Panel is also available when using the test set directly, provided that a mouse or other pointing device is attached to it.

Using the mouse, right-click the application display window, then select **Utility > Virtual Front Panel**. The Virtual Front Panel appears, as shown below:



When you click a button in the Virtual Front Panel, it performs the operation of the corresponding test set front-panel key. The buttons at the left of the panel, named Key 1 through Key 7, perform the operation of the respective softkeys. The Rpg Up and Rpg Down keys perform the operation of the knob.

## Capturing/Printing Displays and Windows

You need an external keyboard and mouse to use this feature.

### Save the desktop:

Step	Notes
1 Press <b>Print Screen</b> on the external keyboard	This captures the desktop and saves it on the Windows clipboard.
2 Open a graphics software program like Microsoft Paint	
3 Paste the clipboard contents into the program	The keyboard shortcut <b>Ctrl + v</b> will paste the contents of the clipboard.
4 Save the image in a file	

### Save the current active window:

Step	Notes
1 Click on the window you want to capture	This activates the window.
2 Press <b>Alt + Print Screen</b> on the external keyboard	This captures the window and saves it on the Windows clipboard.
3 Open a graphics software program like Microsoft Paint	
4 Paste the clipboard contents into the program.	The keyboard shortcut <b>Ctrl + v</b> will paste the contents of the clipboard.
5 Save the image in a file.	

## Windows Shortcuts and Miscellaneous Tasks

This section provides a list of Windows shortcuts (key combinations) that are useful when you operate the test set without an attached mouse and keyboard. (See also “Navigating Windows Without a Mouse” on page 76.) Although these shortcuts are available in any Windows system, they are not commonly used when a mouse and keyboard are attached.

### Windows shortcuts (key combinations)

You can use the following combinations of front panel keys to perform basic Windows tasks when using the test set without an attached mouse and keyboard.

#### Windows shortcut key combinations

To do the following:	Press:
Display the Windows Start Menu	<b>Ctrl+Esc</b>
Cycle through all open applications	<b>Alt+Tab</b>
Select the first menu of a menu bar	<b>Alt</b>
Move through menu headings	<b>Left Arrow, Right Arrow</b>
Open (drop down) a menu	<b>Down Arrow</b>
Move through items in an expanded menu	<b>Up Arrow, Down Arrow</b>
Close the current menu selection	<b>Esc</b>
Cancel the current menu bar selection	<b>Alt</b>
Open an application’s control menu (usually the left-most menu on the menu bar, starting with File)	<b>Alt+Select</b>
In a dialog: move between tabs	<b>Ctrl+Tab</b>
In a dialog: move forward through dialog box items	<b>Tab</b>
In a dialog: move backward through dialog box items	<b>Shift+Tab</b>
In a dialog: open a list box	<b>Alt+Down Arrow</b>
In a dialog list box or check box: select or deselect items	<b>Select</b>
In a dialog list box or check box: select or deselect one item at a time	<b>Shift+Up Arrow, Shift+Down Arrow</b>
In My Computer, expand a selected folder	<b>Enter</b>
In My Computer, open a folder one level up from the current folder	<b>Bk Sp</b>

## Navigating an Application Menu without a Mouse or Keyboard

This example uses Microsoft Excel, but you can use a similar sequence of operations to select and execute any menu item of any application.

To select and execute the item **Sheet > Rename** option from the **Format** menu in the menu bar shown below,

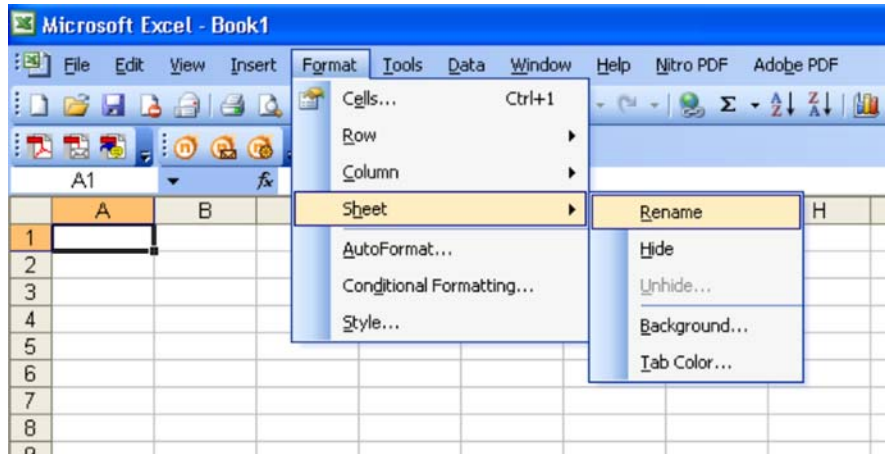

perform the following operations:

Step	Notes
1 Press <b>Alt</b> to select the <b>File</b> menu in the menu bar.	The focus must be in the appropriate window.
2 Use the <b>Right Arrow</b> and <b>Left Arrow</b> keys to move horizontally to the Format menu.	
3 Press the <b>Down Arrow</b> to expand the Format menu.	
4 Use the <b>Down Arrow</b> and <b>Up Arrow</b> keys to move vertically to the Sheet menu item.	
5 Press the <b>Right Arrow</b> key to expand the Sheet sub-menu.	The Rename sub-menu item appears already selected. If another item in the same sub-menu is required, use the <b>Down Arrow</b> and <b>Up Arrow</b> keys to move vertically to that item.
6 Press Enter to execute the selected action.	

## Windows taskbar auto-hide feature

The Windows taskbar should always be in the auto-hide mode when using the test set application. If the taskbar is not set to auto-hide, the lower part of the test set display is obscured by the taskbar.

If a mouse is attached to the test set, and you move the mouse cursor to the bottom of the display (either deliberately or accidentally), the taskbar automatically appears. Provided that the taskbar is in auto-hide mode, you can make it disappear again by moving the mouse cursor away from the bottom of the screen.

If at any time the Windows taskbar is inadvertently set to the non-auto-hide mode, you can restore the auto-hide behavior by doing the following:

### Restoring taskbar auto-hide mode

Step	Notes
1 Click <b>Start &gt; Control Panel</b>	If not using a mouse, press <b>Ctrl+Esc</b> .
2 In Classic View, click <b>Taskbar and Start Menu</b> , or, in Category View, click <b>Appearance and Themes, Taskbar and Start Menu</b>	If you are not using a mouse, use the shortcut key combinations specified in the Section "Windows shortcuts (key combinations)" on page 92 to make these selections.
3 Click the <b>Taskbar</b> tab	The Taskbar and Start Menu Properties dialog appears.

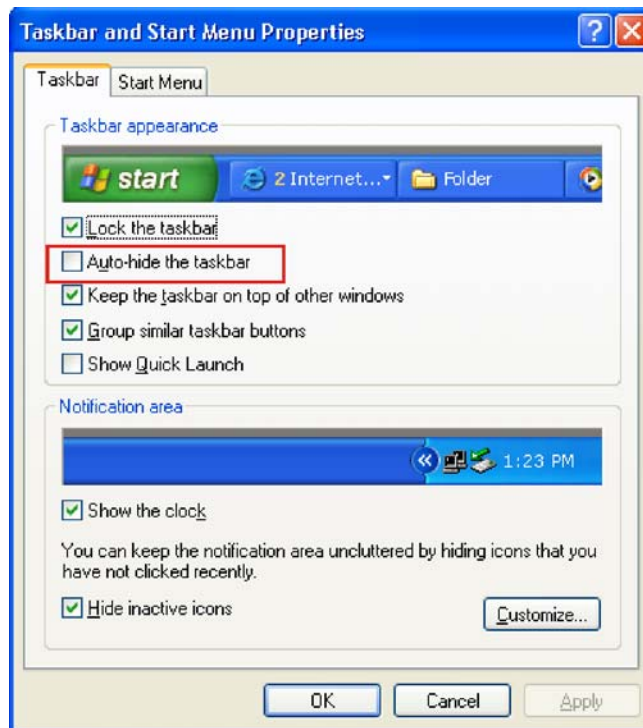

- 4 Select the **Auto-hide the taskbar** check box. If you are not using a mouse, press **Tab** repeatedly until the auto-hide option is selected, then press **Select** to toggle the check box state.

**Restoring taskbar auto-hide mode**

Step	Notes
5 Click <b>OK</b> .	This applies the change and closes the dialog box.

**Windows startup folder**

All Windows systems include a special folder, called the Startup folder. If a program, or a shortcut to a program, is placed in the Startup folder (either by Windows itself, or by a third-party application, or by any user), that program automatically runs every time Windows is restarted.

When your test set is first configured by Agilent, shortcuts to the appropriate application software and supporting programs are placed in the Startup folder. The exact contents of the Startup folder depends on the options you purchased with your test set.

**Important**

You should *never* delete items that appear in the Startup folder, or move any item from the Startup folder to another folder. Deleting or moving any item in the Startup folder may cause applications not to start automatically when Windows is restarted, or may cause certain options to be unavailable when using the test set.

If you wish to view the contents of the Startup folder, do one of the following:

- Either click **Start, All Programs**, then select **Startup**,  
or,
- Click **Start, My Computer**, then navigate to the folder:  
**C:\Documents and Settings\All Users\Start Menu\Programs\Startup**.

Additional startup items may also appear in the corresponding startup folder for the user that is currently logged on. For example, the startup folder for the **administrator** user is **C:\Documents and Settings\administrator\Start Menu\Programs\Startup**.

## **4 Using Microsoft Windows Operating System**





## 5 Troubleshooting

“Check the Basics” on page 98

“Problems with Microsoft Windows Operating System” on page 100

“Returning a test set for Service” on page 101

**WARNING**

No operator serviceable parts inside. Refer servicing to qualified personnel.  
To prevent electrical shock do not remove covers.

---



### Check the Basics

- o Is there power at the receptacle?
- o Is the test set turned on? Check to see if the green LED beside the power switch is on. Also, listen for internal fan noise to determine if the test set cooling fans are running.
- o If other equipment, cables, and connectors are being used with your test set, make sure they are connected properly and operating correctly.
- o If the analyzer cannot completely load or run the operating system, or the instrument application is not successfully launched, the problem could be a corrupt hard drive. If the analyzer gets far enough along in the boot process to run the "Agilent Recovery System", perform the "[Hard Drive Recovery Process](#)" on page 65.
- o Is the Measurement Application running? If not, there is a software launch shortcut/icon on the desktop.
- o Does the test set application have the focus? (That is, is the blue window banner highlighted?) If not, move focus to the application with Alt-Tab.
- o Review the measurement procedures being performed when the problem first appeared. Are all of the settings correct?
- o If the test set is not functioning as expected, return the test set to a known state by pressing **Mode Preset**.

#### NOTE

Some test set settings are not affected by a Preset. If you wish to reset the test set settings, press **System, Power On, Restore Power On Defaults**.

- 
- o Is the measurement being performed, and the results that are expected, within the specifications and capabilities of the test set? Refer to the specifications guide for your test set. Technical manual pdf files are available in the test set (C:\Program Files\Agilent\SignalAnalysis\Infrastructure\Help\files), on the documentations cd provided with the test set, and on the Agilent website: <http://www.agilent.com/find/E6630A>
  - o If the test set is not communicating via the LAN connection, check for the presence of blinking yellow LEDs on the rear panel LAN connector. If the ACT LED is not blinking, check the LAN cable and LAN integrity.
  - o To meet specifications, the test set must be aligned. Either the Auto Align (On) feature must be selected (press **System, Alignments, Auto Align, Normal**), or the test set must be manually aligned.
  - o Perform an Alignment. Press **System, Alignments, Align Now, All**.

- o If the previously performed alignments did not resolve the problem, press **System, Alignments, Restore Align Defaults**. Then press **System, Alignments, Align Now, All**.
- o Is the test set displaying an error message? If so, refer to the Instrument Messages Guide.
- o Check if the external frequency reference is selected but not available. Verify that it is selected by pressing **Input/Output, Freq Ref In**. If **External** is selected, changing the setting to **Sense** allows the test set to sense the presence of an external reference and use it only if it is available. The frequency of the reference should be set correctly.
- o If you are using a Windows program, other than the test set application, you may notice it running slow. Place the test set application in single sweep/measurement.

**Tip**

You can get automatic electronic notification of new firmware releases and other product updates/information by subscribing to the *Agilent Technologies Test & Measurement E-Mail Notification Service* for your test set at <http://agilent.com/find/notifyme>

---

## Problems with Microsoft Windows Operating System

The Microsoft Windows operating system settings have been optimized for the best performance. Modification of these settings may degrade test set performance and measurement speed. Those that can be safely modified are described in “Settings that can be changed” on page 53.

The E6630A Wireless Connectivity Test Set operates in an open Windows environment, so you can install software on the test set. However, installation of non-approved software may affect test set performance. Agilent does not warrant the performance with non-approved software installed.

## Returning a test set for Service

### Calling Agilent Technologies

Agilent Technologies has offices around the world to provide you with complete support for your test set. To obtain servicing information or to order replacement parts, contact the nearest Agilent Technologies office listed in the following table. In any correspondence or telephone conversations, refer to your test set by its product number, full serial number, and software revision.

Press **System, Show, System**, and the product number, serial number, and software revision information is displayed on your test set screen. A serial number label is also attached to the rear panel of the test set.

### Locations for Agilent Technologies

#### Americas

Canada  
+1 877 894-4414

Brazil  
+55 11 3351-7012

Mexico  
+001 0800 254-2440 ext 2610

United States  
+1 800 829-4444  
Press # then 3

#### Africa & Middle East

Israel  
+972 3 9288 600

South Africa  
+2712 678 9200

Turkey  
+90-312-466 8212

#### Asia & Pacific

Australia  
1 800-225-574

China  
800-810-0189 / 400-810-0189

Hong Kong  
800-938-693

India  
1-800-11-2626

Japan  
0120-412-766

Korea  
080-769-0800

Malaysia  
1 800-888-848

New Zealand  
64 4 570 248

Philippines  
+632 850-4347/49

Singapore  
1 800-375-8100

Taiwan  
0800-047-866

Thailand  
1 800-291-222

Vietnam  
120-65-201

#### Europe

Denmark  
45 45 80 1215

Finland  
010 855 2100

France  
0825-01-07-00

Germany  
+49 (0) 7031 464 6333

Italy  
+39 02 9260 8484

Netherlands  
+31 0 20 547 2111

## 5 Troubleshooting

Russia  
+7 (495) 797 3930

Spain  
91 631 3300

Sweden  
0200-88 22 55

United Kingdom  
+44 0 118 927 6201

**Online assistance:** <http://www.agilent.com/find/assist>

**Contact us:** <http://www.agilent.com/find/contactus>

### Read the Warranty

The warranty for your test set is in the front of your Specifications Guide. Please read it and become familiar with its terms.

If your test set is covered by a separate maintenance agreement, please be familiar with its terms.

### Service Options

Agilent Technologies offers several optional maintenance plans to service your test set after the warranty has expired. Call your Agilent Technologies office for full details.

If you want to service the test set yourself after the warranty expires, you can purchase the service documentation that provides all necessary test and maintenance information.

You can order the service documentation, *Option OBW* (assembly level troubleshooting information) through your Agilent Technologies office.

## Packaging the Test Set

Use original packaging or comparable. It is best to pack the unit in the original factory packaging materials if they are available.

**CAUTION**

Test set damage can result from using packaging materials other than those specified. Never use styrene pellets in any shape as packaging materials. They do not adequately cushion the test set or prevent it from shifting in the carton. They cause test set damage by generating static electricity and by lodging in the test set louvers, blocking airflow.

You can repackage the test set with commercially available materials, as follows:

Step	Notes
1 Wrap the test set in antistatic plastic to reduce the possibility of damage caused by electrostatic discharge.	
2 Use a strong shipping container.	The carton must be both large enough and strong enough to accommodate the test set. A double-walled, corrugated cardboard carton with 159 kg (350 lb) bursting strength is adequate. Allow at least 3 to 4 inches on all sides of the test set for packing material.
3 Surround the equipment with three to four inches of packing material and prevent the equipment from moving in the carton.	If packing foam is not available, the best alternative is plastic bubble-pak. This material looks like a plastic sheet filled with 1-1/4 inch air bubbles. Use the pink-colored bubble which reduces static electricity. Wrapping the equipment several times in this material should both protect the equipment and prevent it from moving in the carton.
4 Seal the shipping container securely with strong nylon adhesive tape.	
5 Mark the shipping container “ <b>FRAGILE, HANDLE WITH CARE</b> ” to assure careful handling.	
6 Retain copies of all shipping papers.	

## 5 Troubleshooting



# Index

## Symbols

.NET, 55

## A

add

- a network connection, 53
- a printer, 54

Administrator logon, 44

Adobe Acrobat Reader, 55

Agilent directories and files, 55

Agilent I/O Libraries, 55

Agilent Recovery System, 65, 66

Agilent Technologies

locations, 102

Agilent Technologies, calling, 101

Agilent-Only user accounts, 55

anti virus programs, 53

anti-virus software, 43, 60

Auto-hide Taskbar, 93

automatic updates, 58, 59

Automatic Updates, Microsoft Windows, 53

## B

backing up your instrument, 62

battery replacement, 24

boot wait time, 73

## C

C drive usage, 64

changing

Windows system settings, 53

classic Windows display, 54

Computer Name, 82

computer name

how to locate it, 79

connectors, front panel, 28

contents of shipment, 13

Control Panel

taskbar, 93

Control Panel access, 56

Control Panel settings that can be changed, 53

controlling Windows without a mouse, 76

cooling the instrument, 14

## D

D drive data storage, 64

data storage, 64

date and time setting, 54

defragmenting your disk, 62

desktop saving, 91

Device Manager settings, Microsoft Windows, 54

Device USB port, 63

directories, Agilent, 55

disk defragmentation, 62

disk drive partitioning, 55

display annotations, 36

display print, 91

display save, 91

Display settings, Microsoft Windows, 54

Domain Name, 82

drive C use, 64

drive D use, 64

drive partitioning, 55

drive recovery, 65

Drivers settings, Microsoft Windows, 54

## E

E6630A

Computer Name, 82

computer name, 79

Domain Name, 82

popup menus, 85

virtual front panel, 90

windows system, 75

electrostatic discharge (ESD)

protecting against, 26

Environment Variables settings,

Microsoft Windows, 54

environmental conditions, 23

Error Reporting settings, Microsoft Windows, 54

## F

file backup, 62

firewalls, 58, 59

fixing the hard disk, 66

font size, changing, 54

Fonts removal, Microsoft Windows, 54

front panel

connectors and keys, 28

keycode alternates, 86

popup menu alternative, 85

shortcut keys, 86

symbols, 39

virtual, 90

fuses, 22

## G

gateway setting, 57

GPIB27 or GPIB28, 55

## H

hard disk recovery process, 66

hard drive recovery, 65

Hibernate, Microsoft Windows, 54

Host USB ports, 63

hostname setting, 57

## I

IIS server, 55

initialization with mouse, 15

installing other software, 43

installing programs to drive C, 64

instrument location, 14

Instrument logon, 44, 45

instrument recovery, 66

instrument ventilation, 14

IP address setting, 57

## K

Keycode Commands

Windows, 92

keycode commands, 86

keys, 28

shortcut, 86

## L

LAN configuration, 57

licenses for software, 42

line voltage, 22

loading a printer driver, 56

loading other software, 43

locating the instrument, 14

logon

accounts, 45

administrator, 44

instrument, 44

## M

Microsoft SQL Server Desktop Engine, 55  
 Microsoft Visual J# .NET, 55  
 Microsoft Windows  
   Automatic Updates, 53  
   Display settings, 54  
   Fonts removal, 54  
   network connection Windows  
     **network connection**, 53  
   Power Options, 54  
   printer install and configure, 54  
   set screen saver, 54  
   set time and date, 54  
   System Properties, 54  
   Tab settings, 54  
   user accounts, 53  
   virus protection, 53  
 Microsoft Windows system settings, 53  
 mouseless Windows navigation, 76  
 MSSQL\$CDF service, 55  
 My Documents location, 64

## N

navigating without a mouse, 76  
 network connection, Microsoft Windows, 53

## O

operating remotely, 77

## P

packaging, 103  
 partitioning the hard-disk drive, 55  
 passwords, 44, 45  
 Performance settings, Microsoft Windows, 54  
 power cords, 23  
 Power Options, Microsoft Windows, 54  
 power source, 22  
 power-on time, 21  
 print screen, 91  
 printer driver loading, 56  
 printer install and configure, Microsoft Windows, 54  
 printer setup, 56  
 printing a window, 91  
 printing the desktop, 91  
 problems with shipment, 14  
 program storage, 64

## R

rack mounting, 14  
 rear panel  
   symbols, 39

rear panel features, 38  
 recovering the hard drive, 65  
 recovery process, 66  
 recovery timing, 73  
 reduce power-on time, 21  
 registry entries, 55  
 Remote Desktop  
   keycodes, 86  
   running, 81  
 Remote Operation  
   Connection Speed, 82  
 remote operation, 77  
 replacing battery, 24  
 restoring your instrument, 62  
 running Windows without a mouse, 76

## S

saving a window image, 91  
 saving data to internal drives, 64  
 saving programs on C drive, 64  
 saving the desktop image, 91  
 screen capture, 91  
 screen resolution setting, Microsoft Windows, 54  
 screen saver settings, Microsoft Windows, 54  
 security, 58  
 service options, 102  
 services running, 55  
 setting  
   gateway, 57  
   hostname, 57  
   ip address, 57  
   LAN, 57  
 shipment contents, 13  
 Shortcut keys  
   Windows, 92  
 shortcut keys, 86  
 software installed by customers, 43  
 software licenses, 42  
 spyware, 61  
 Startup and Recovery settings, Microsoft Windows, 54  
 Startup Folder  
   Windows, 95  
 storing data on D drive, 64  
 symbols, on front and rear panels, 39  
 system backup, 62  
 System Properties, Microsoft Windows, 54  
 system recovery, 65  
 system restore, 62  
 system settings that can be changed, 53

## T

Tab settings, Microsoft Windows, 54  
 Taskbar  
   Windows, 93  
 test set software, 42

third party software, 43  
 time and date setting, Microsoft Windows, 54  
 turn on  
   with a mouse, 15

## U

updates, automatic, 53  
 updating Windows, 59  
 URL  
   contact us, 102  
   sales and service, 102  
 USB host ports, 63  
 USB Series A or B ports, 63  
 User Accounts location, 64  
 user accounts, Microsoft Windows, 53  
 user logon, 44  
 user logon accounts, 45  
 User Profiles settings, Microsoft Windows, 54  
 user startup folder, 95  
 using the test set remotely, 77  
 using Windows without a mouse, 76

## V

V9060A software, 42  
 V9077A software, 42  
 verifying contents, 13  
 virtual front panel, 90  
 virus protection, 43, 60  
 virus protection programs, 53

## W

warranty, 102  
 window saving, 91  
 Windows, 76  
   Automatic Updates, 53  
   Control Panel, 93  
   Display settings, 54  
   Fonts removal, 54  
   Power Options, 54  
   print screen, 91  
   printer install and configure, 54  
   Remote Desktop  
     **Installing**, 78  
     **Setting up**, 78  
   screen capture, 91  
   set screen saver, 54  
   set time and date, 54  
   Shortcut keys, 92  
   Startup Folder, 95  
   System Properties, 54  
   Tab settings, 54  
   taskbar  
     **auto-hide**, 93  
   user accounts, 53  
   virus protection, 53

- Windows 7
  - operating system, 75
- Windows Classic Style, 54
- Windows firewall, 59
- Windows Remote Desktop, 77
  - keycodes, 86
  - options, 82
  - Options Dialog
    - Experience Tab, 82
    - General Tab, 82
  - popup menus, 85
  - running, 81
  - Setting up Remote Computer, 78
  - setting up the E6630A, 77
  - Setting up Windows Systems, 78
    - 32-bit, 78
  - virtual front panel, 90
- windows security, 58
- Windows services, 55
- Windows settings, 53
- Windows Style, 54
- Windows updates, 59

